



Owner's handbook
FordFocus
100% Ford. 100% Enjoyment.



The information contained in this publication was correct at the time of going to print. In the interest of development the right is reserved to change specifications, design or equipment at any time without notice and without incurring any obligations. This publication, or part thereof, may not be reproduced nor translated without our approval. Errors and omissions excepted.

© Ford Motor Company 2006

All rights reserved.

Part number: 6M5J-19A321-ADA (CG3505en) 05/2006 20060516172936

Table of Contents

Introduction.....	5	Keyless entry.....	45
About this handbook.....	5	Global opening and closing.....	51
Symbols glossary.....	6	Engine immobiliser.....	53
Parts and accessories.....	6	Principle of operation.....	53
Quick start.....	7	Coded keys.....	53
Child safety.....	22	Arming the engine immobiliser.....	54
Child seats.....	22	Disarming the engine immobiliser.....	54
Child seat positioning.....	23	Alarm.....	55
Booster cushions.....	24	Arming the alarm.....	55
ISOFIX anchor points.....	24	Disarming the alarm.....	56
Child safety locks.....	26	Steering wheel.....	57
Occupant protection.....	27	Adjusting the steering wheel.....	57
Principle of operation.....	27	Horn.....	57
Fastening the seat belts.....	31	Audio control.....	57
Seat belt height adjustment.....	32	Voice control.....	58
Using seat belts during pregnancy.....	32	Pedals.....	59
Rollover bars.....	32	Adjusting the pedals.....	59
Disabling the passenger airbag.....	33	Wipers and washers.....	60
Keys and remote controls.....	36	Windscreen wipers.....	60
General information on radio frequencies.....	36	Windscreen washers.....	62
Programming the remote control.....	36	Rear window wiper and washers.....	62
Changing the remote control battery.....	37	Adjusting the windscreen washer jets.....	63
Locks.....	41	Headlamp washers.....	63
Locking and unlocking.....	41	Checking the wiper blades.....	64
		Changing the wiper blades.....	64

Table of Contents

Lighting.....65

Lighting control.....	65
Front fog lamps.....	66
Rear fog lamps.....	67
Adjusting the headlamps.....	67
Headlamp levelling.....	68
Hazard warning flashers.....	69
Adaptive front lighting system (AFS).....	70
Direction indicators.....	71
Interior lamps.....	71
Removing a headlamp.....	72
Removing a rear lamp.....	73
Changing a bulb.....	74
Bulb specification chart.....	85

Windows and mirrors.....86

Electric windows.....	86
Exterior mirrors.....	88
Electric exterior mirrors.....	89
Interior mirror.....	90

Instruments.....91

Instrument panel overview - LHD.....	91
Instrument panel overview - RHD.....	93
Gauges.....	95
Warning lamps and indicators.....	98
Audible warnings and indicators.....	102

Information displays..104

General information.....	104
Personalised settings.....	108

Information messages.....	121
---------------------------	-----

Climate control.....125

Principle of operation.....	125
Air vents.....	125
Manual climate control.....	126
Automatic climate control.....	129
Heated windows and mirrors.....	132
Auxiliary heater.....	133
Electric sunroof.....	135

Seats.....138

Sitting in the correct position.....	138
Manual seats.....	138
Electric seats.....	141
Head restraints.....	143
Rear seats.....	144
Heated seats.....	145

Convenience features.....146

Sun visors.....	146
Sun blinds.....	146
Instrument lighting dimmer.....	146
Cigar lighter.....	146
Ashtray.....	147
Auxiliary power sockets.....	147
Cup holders.....	147
Glove box.....	147
Centre console.....	148
Storage compartments.....	149
Rear seat armrest.....	150
Glasses holder.....	150
Toll reader.....	150
Auxiliary input (AUX IN) socket.....	150

Table of Contents

Starting the engine....151	Cruise control.....178
General information.....151	Principle of operation.....178
Ignition switch.....151	Using cruise control.....178
Starting a petrol engine.....152	Automatic speed limiter
Starting a diesel engine.....154	(ASL).....180
Diesel particulate filter (DPF).....156	Principle of operation.....180
Switching off the engine.....156	
Fuel and refuelling....157	Load carrying.....181
Safety precautions.....157	Luggage covers.....181
Fuel quality.....157	Rear under floor storage.....181
Catalytic converter.....158	Cargo nets.....182
Fuel filler flap.....158	Roof racks and load carriers.....183
Refuelling.....159	
Technical specifications.....159	Towing.....186
Transmission.....164	Towing a trailer.....186
Manual transmission.....164	Detachable tow ball.....186
Automatic transmission.....165	
Brakes.....172	Convertible top.....190
Principle of operation.....172	Opening the convertible top.....190
Hints on driving with ABS.....172	Closing the convertible top.....191
Parking brake.....173	
Stability control.....174	Driving hints.....196
Principle of operation.....174	Running-in.....196
Using stability control.....175	
Parking aid.....176	Emergency
Principle of operation.....176	equipment.....197
Using the parking aid.....176	First aid kit.....197
	Warning triangle.....197
	Status after a
	collision.....199
	Fuel cut-off switch.....199
	Inspecting safety system
	components.....199

Table of Contents

Fuses.....200

- Fuse box locations.....200
- Changing a fuse.....201
- Fuse specification chart.....202

Vehicle recovery.....207

- Towing points.....207
- Towing the vehicle on four wheels.....208

Maintenance.....209

- General information.....209
- Opening and closing the bonnet.....210
- Engine compartment overview.....211
- Engine oil check.....218
- Engine coolant check.....220
- Brake and clutch fluid check.....221
- Power steering fluid check.....222
- Washer fluid check.....222
- Technical specifications.....222

Vehicle care.....226

- Cleaning the exterior.....226
- Cleaning the interior.....226
- Repairing minor paint damage....227

Vehicle battery.....228

- Battery care.....228
- Using booster cables.....228
- Changing the vehicle battery.....229

Wheels and tyres.....230

- Changing a road wheel.....230

- Tyre care.....235
- Tyre repair kit.....235
- Using winter tyres.....241
- Using snow chains.....241
- Technical specifications.....241

Vehicle identification.....245

- Vehicle identification plate.....245
- Vehicle identification number (VIN).....245
- Engine number.....245

Technical specifications.....246

- Technical specifications.....246

Type approvals.....262

Introduction

ABOUT THIS HANDBOOK

Please take the time to get well acquainted with your vehicle by reading your owner literature. The more you know and understand about your vehicle the greater the safety, economy, and pleasure you will derive from driving it.

The Owner's handbook describes every option and model variant available in every European country and therefore some of the items covered may not apply to your particular vehicle. Furthermore, due to printing cycles it may describe options before they are generally available.

Regular servicing of your vehicle helps maintain both its roadworthiness and its resale value. A network of more than 7 000 Ford authorized repairers throughout Europe can help you with their professional servicing expertise.

Their specially trained personnel are best qualified to service your vehicle properly and expertly. Also, they are supported by a wide range of highly specialised tools and equipment specially developed for servicing Ford vehicles.

Note: Remember to pass on the Owner's handbook when reselling the vehicle. It is an integral part of the vehicle.

Ford**Focus** has received both the endorsement of TÜV, the accredited international testing organisation, and been awarded the British Allergy Foundation's 'Seal of Approval' for its allergy-friendly properties.



E78239

All materials used in the manufacture of the interior of this vehicle meet strict requirements of the TÜV TOXPROOF Criteria Catalogue for Vehicle Interiors by TÜV Produkt and Umwelt GmbH and are designed to minimize the risk of allergic reactions.

Additionally an efficient pollen filter protects the passengers against allergizing particles in the outdoor air.



E78240

The British Allergy Foundation (BAF) considers that these products may, in proper use, reduce exposure to chromium, nickel, latex, grass pollen and other sensitizing substances and volatile organic compounds.

Introduction

Assessment carried out by BAF indicates that an individual's allergic symptoms will necessarily diminish. BAF's opinion applies only to the products and allergen stated.

Exposure to allergen can be dangerous. If you believe that you may suffer from an allergy you should seek medical advice.

The British Allergy Foundation's Seal of Approval is a European Community registered trademark.

For more info. Contact TÜV at www.tuvdotcom.com/pi/web/index.xml or the British Allergy Foundation (Charity Reg. No. 1094231) at www.allergyuk.org or ring their English only Helpline at UK 44-(0)-1322-619864.

SYMBOLS GLOSSARY

Symbols in this handbook

WARNING



You risk death or serious injury to yourself and others if you do not follow the instructions highlighted by the warning symbol.

CAUTION



You risk damaging your vehicle if you do not follow the instructions highlighted by the caution symbol.

Symbols on your vehicle



When you see these symbols, read and follow the relevant instructions in this handbook before touching or attempting adjustment of any kind.

PARTS AND ACCESSORIES

Genuine Ford parts and accessories have been designed specifically for your vehicle. Unless we have specifically stated, we have not tested non-Ford parts and accessories and, therefore, we will not guarantee that they are suitable for your vehicle. We recommend that you ask your Ford Dealer for advice on parts and accessories suitable for your vehicle.

Quick start

Instrument panel overview

Left-hand drive

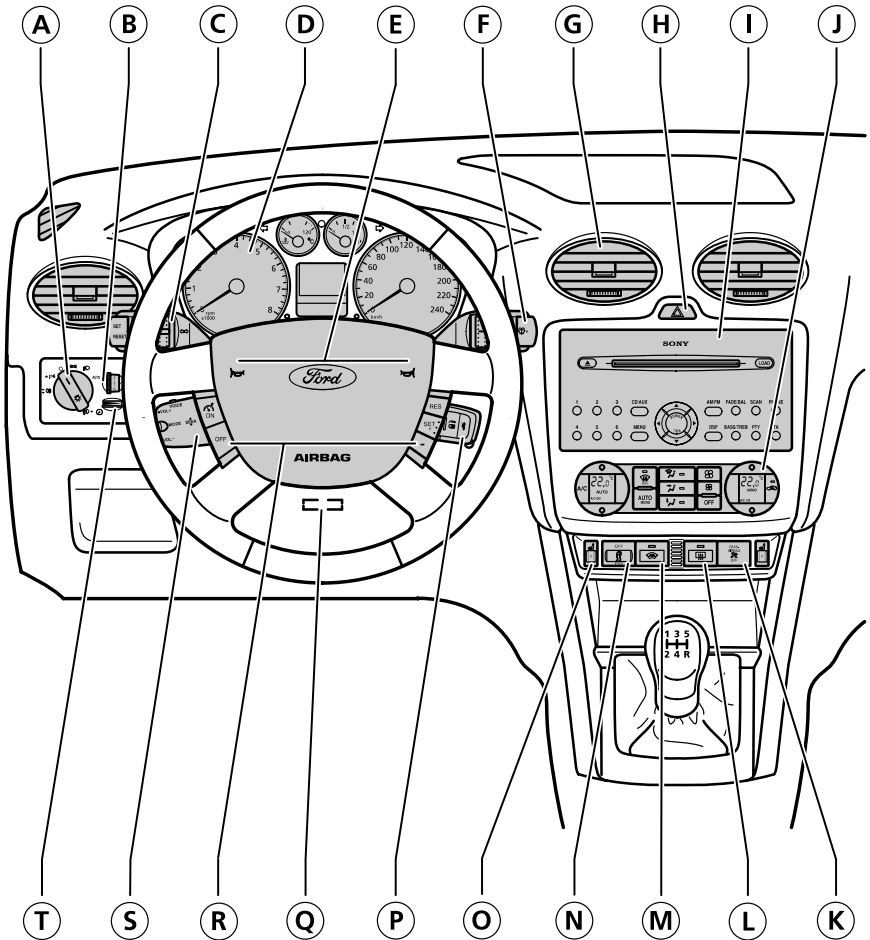

E78773

Quick start

- A Lighting control. See **Lighting control** (page 65). Front fog lamps. See **Front fog lamps** (page 66). Rear fog lamp. See **Rear fog lamps** (page 67).
- B Headlamp levelling control. See **Headlamp levelling** (page 68).
- C Multi-function lever: Information display controls. See **Information displays** (page 104). Direction indicators. See **Direction indicators** (page 71). Main beam. See **Lighting control** (page 65).
- D Instrument cluster. See **Gauges** (page 95). See **Warning lamps and indicators** (page 98).
- E Horn. See **Horn** (page 57).
- F Wiper lever. See **Wipers and washers** (page 60).
- G Air vents. See **Air vents** (page 125).
- H Hazard warning flasher switch. See **Hazard warning flashers** (page 69).
- I Audio and navigation unit. See separate handbook.
- J Climate controls. See **Climate control** (page 125).
- K Stability control (ESP) switch (convertible). See **Stability control** (page 174).
- K Airbag deactivation indicator (all except convertible). See **Disabling the passenger airbag** (page 33).
- L Heated rear window switch. See **Heated windows and mirrors** (page 132).
- M Heated windscreen switch. See **Heated windows and mirrors** (page 132).
- N Convertible top switch (convertible). See **Convertible top** (page 190).
- N Stability control (ESP) switch (all except convertible). See **Stability control** (page 174).
- O Heated front seat switch. See **Heated seats** (page 145).
- P Ignition switch. See **Ignition switch** (page 151).
- Q Steering wheel adjustment. See **Adjusting the steering wheel** (page 57).
- R Cruise control switches. See **Using cruise control** (page 178).
- S Audio controls. See **Audio control** (page 57).
- T Instrument lighting dimmer. See **Instrument lighting dimmer** (page 146).

Quick start

Right-hand drive

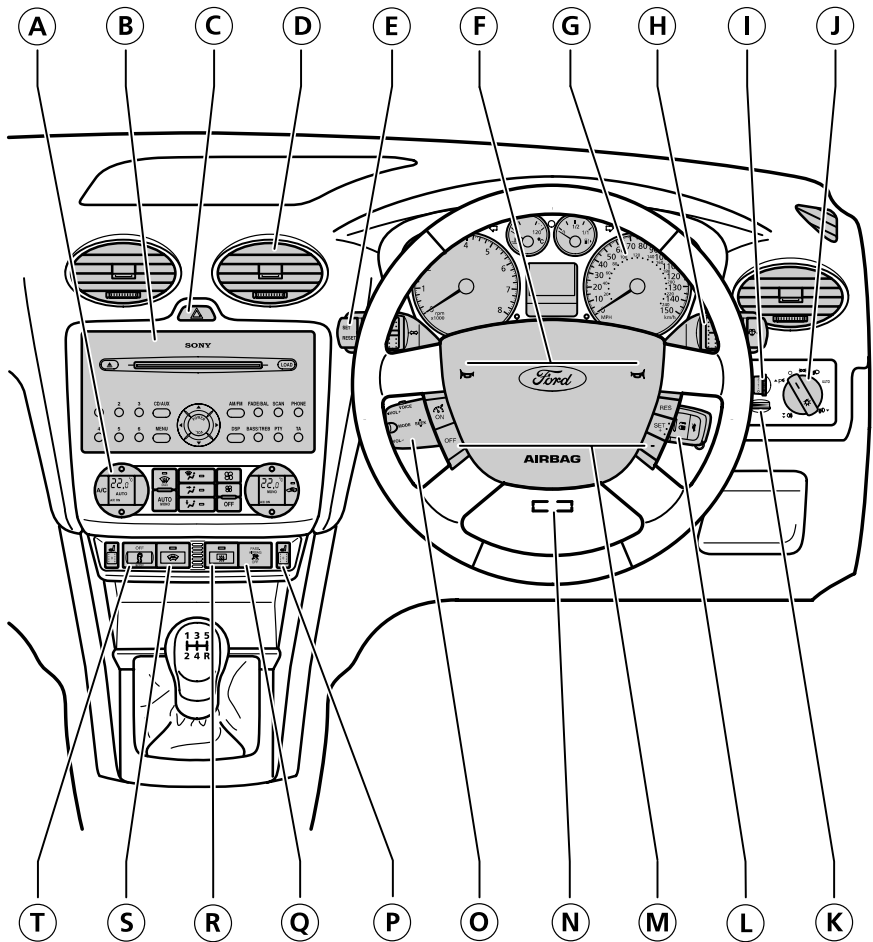

E78774

- A Climate controls. See **Climate control** (page 125).
- B Audio and navigation unit. See separate handbook.

Quick start

- C Hazard warning flasher switch. See **Hazard warning flashers** (page 69).
- D Air vents. See **Air vents** (page 125).
- E Multi-function lever: Information display controls. See **Information displays** (page 104). Direction indicators. See **Direction indicators** (page 71). Main beam. See **Lighting control** (page 65).
- F Horn. See **Horn** (page 57).
- G Instrument cluster. See **Gauges** (page 95). See **Warning lamps and indicators** (page 98).
- H Wiper lever. See **Wipers and washers** (page 60).
- I Headlamp levelling control. See **Headlamp levelling** (page 68).
- J Lighting control. See **Lighting control** (page 65). Front fog lamps. See **Front fog lamps** (page 66). Rear fog lamp. See **Rear fog lamps** (page 67).
- K Instrument lighting dimmer. See **Instrument lighting dimmer** (page 146).
- L Ignition switch. See **Ignition switch** (page 151).
- M Cruise control switches. See **Using cruise control** (page 178).
- N Steering wheel adjustment. See **Adjusting the steering wheel** (page 57).
- O Audio controls. See **Audio control** (page 57).
- P Heated front seat switch. See **Heated seats** (page 145).
- Q Convertible top switch (convertible). See **Convertible top** (page 190).
- Q Airbag deactivation indicator (all except convertible). See **Disabling the passenger airbag** (page 33).
- R Heated rear window switch. See **Heated windows and mirrors** (page 132).
- S Heated windscreen switch. See **Heated windows and mirrors** (page 132).
- T Stability control (ESP) switch. See **Stability control** (page 174).

Warning lamps and indicators



ABS warning lamp



Airbag warning lamp



Brake system warning lamp

Quick start



Cruise control indicator



Direction indicator



Doors open warning lamp



Engine systems fault warning lamp



Engine warning lamp



Front fog lamp indicator



Frost warning lamp



Glow plug indicator



Headlamp indicator



Ignition warning lamp



Low fuel level warning lamp



Main beam indicator



Maximum engine RPM warning lamp



Oil pressure warning lamp



Power steering warning lamp



Rear fog lamp indicator



Seat belt reminder



Stability control (ESP) indicator

See **Warning lamps and indicators** (page 98).

Information display

Chime deactivation

MESSAGE CHIMES
ON /OFF ✓

E78489

Scroll to this display in the **Your settings** menu and press **SET and RESET** to toggle the chimes on and off.

See **Information displays** (page 104).

Clock setting

CLOCK SETTING
12:59 31.12.04

E78490

Vehicles with a Ford audio or navigation system: the clock is set on the audio or navigation system. See the relevant handbook.

Quick start

Vehicles with a programmable auxiliary heater but no Ford audio or navigation system: See **Information displays** (page 104).

Manual climate control

Windscreen defrosting and demisting

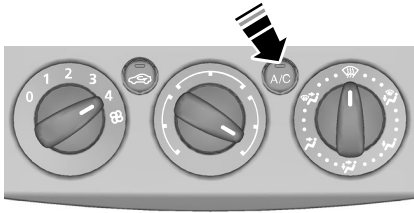

E71382

Rapid heating of vehicle interior

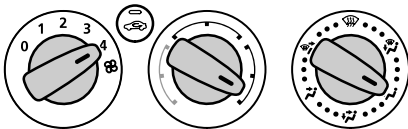

E77935

See **Manual climate control** (page 126).

Automatic climate control

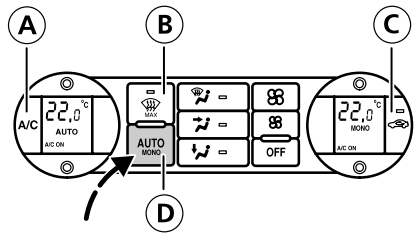

E78730

- A Air conditioning ON and OFF
- B Windscreen defrosting and demisting
- C Recirculated air
- D To toggle mono mode on and off, press and hold for two seconds

Recommended settings: AUTO, 22°C

See **Automatic climate control** (page 129).

Autolamps

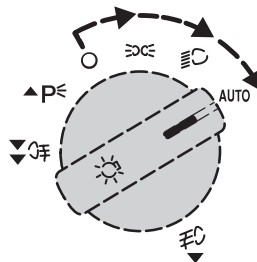

E72162

Quick start

When the lighting control is set to position AUTO the dipped beam headlamps will switch on and off automatically depending on the ambient light.

See **Lighting control** (page 65).

Direction indicators

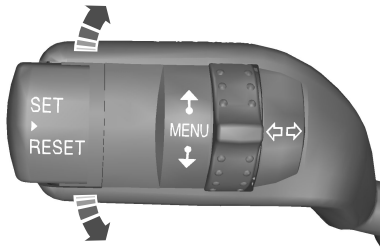

E71098

If the lever is tapped up or down, the direction indicators will flash three times.

See **Direction indicators** (page 71).

Adjusting the steering wheel

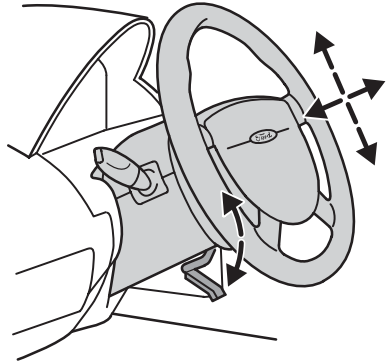

E70358

Adjust only when the vehicle is stationary.

See **Adjusting the steering wheel** (page 57).

Autowipers

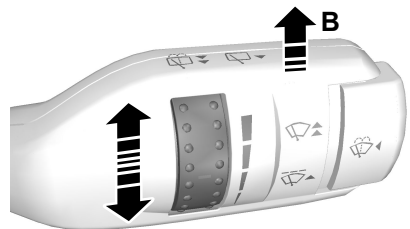

E71014

Move the lever up one position.

Quick start

The rain sensor will continuously measure the amount of water on the front screen and adjust the speed of the front wipers automatically.

Adjust the sensitivity of the rain sensor using the rotary control.

See **Windscreen wipers** (page 60).

Electric windows

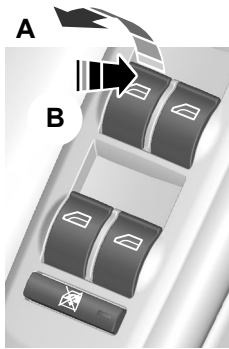

E70848

- A To close: lift up the front of the switch
- B To open: press down the front of the switch

Locking and unlocking

Unlocking the vehicle

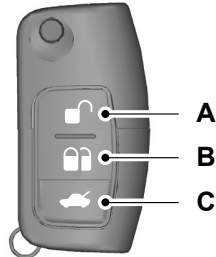

E71963

- A Unlock
- B Lock
- C Tailgate unlock

Press the unlock button once to unlock the vehicle. See **Programming the remote control** (page 36).

Press and hold the unlock button for three seconds to unlock the vehicle and open the windows and sunroof (global opening)*.

Press the lock button once to activate central locking and arm the alarm.

All except convertible - Press the lock button twice within three seconds to activate double locking and arm the interior sensors.

Convertible only - Press the lock button once to activate double locking and arm the interior sensors.

Quick start

Press and hold the lock button for three seconds to lock the vehicle and close the windows and sunroof (global closing)*.

Press the tailgate unlock button twice within three seconds to unlock the luggage compartment.

* only in combination with four electric windows (in combination with two electric windows, only the sunroof can be opened and closed in this way).

Opening the tailgate

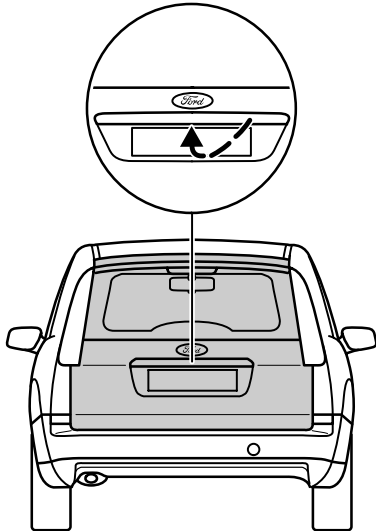

E78262

To open the luggage compartment, press the switch. The driver's door must be unlocked.

See **Locking and unlocking** (page 41).

Key free system

Passive key

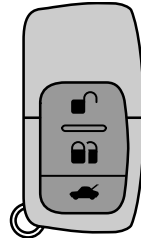

E78277

WARNING

 Do not store the passive key with metal objects or electronic devices such as mobile phones as this could cause interference with the key free system.

Unlocking the vehicle

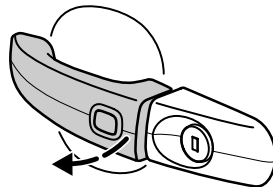

E78278

Pull any door handle to unlock **all** the doors and the tailgate and disarm the alarm.

Quick start

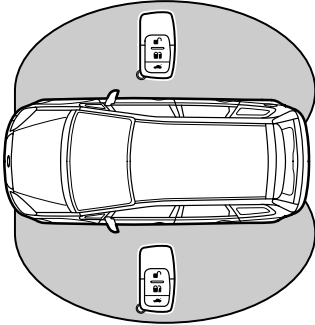

E78279

Note: A valid passive key must be located within the detection range of that door.

The direction indicators will flash once to confirm that the vehicle is unlocked.

The unlocking function can be reprogrammed so that only the driver's door is unlocked. See **Programming the remote control** (page 36).

If the unlocking function is reprogrammed so that only the driver's door is unlocked, note the following:

If the driver's door is the first door which is opened, the other doors and the tailgate will remain locked.

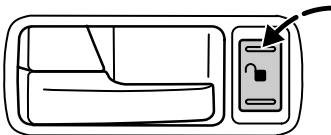

E78281

To unlock the other doors and the tailgate from inside, press the button next to the driver's door handle.

If one of the passenger's doors is the first door which is opened, all the doors and the tailgate will be unlocked.

Starting the engine

Depress the clutch pedal (vehicles with manual transmission) or the brake pedal (vehicles with an automatic transmission).

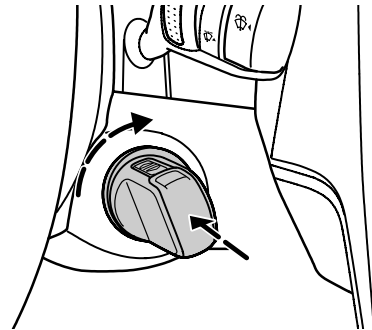

E78300

Note: A valid passive key must be located within the vehicle interior.

Push the ignition switch in and turn it to switch on the ignition and to start the engine.

PASSIVE KEY
NOT DETECTED

E78491

If no passive key is detected, **PASSIVE KEY NOT DETECTED** will appear in the information display.

Quick start

Engaging the steering lock

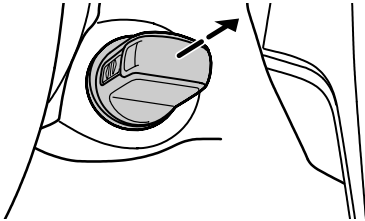

E78087

Turn the ignition switch to position **O** and pull it out approximately 5 mm.

Turn the steering wheel to engage the steering lock.

**PLEASE ENGAGE
STEERING LOCK**

E78492

If the ignition switch is not pulled out, **PLEASE ENGAGE STEERING LOCK** will appear in the information display and a chime will sound when the driver's door is opened.

Locking the vehicle

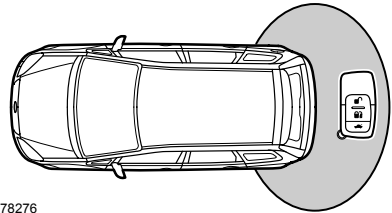
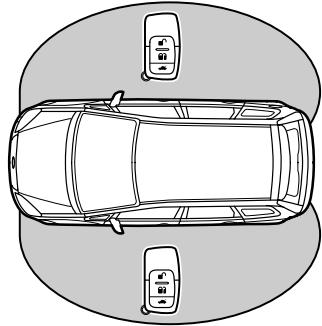

E78276

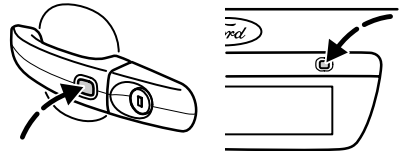

E78282

WARNING

 The vehicle does not lock itself automatically. If no locking button is pressed, the vehicle will remain unlocked.

Note: A valid passive key must be located within the detection range of the respective door or the tailgate.

Quick start

Note: Once locked, the vehicle cannot be unlocked for three seconds. This is to allow you to pull a door handle and check if the vehicle is locked.

Press the locking button on the driver's or front passenger's door or the tailgate **once** to activate **central locking** and arm the alarm.

On vehicles without double locking, the direction indicators will flash twice to confirm that the vehicle is locked.

All except convertible - Press the button **twice within three seconds** to activate **double locking** and arm the alarm with interior sensors.

Convertible only - Press the locking button on one of the front doors or the tailgate **once** to activate **double locking** and arm the alarm with interior sensors.

The direction indicators will flash twice to confirm that the vehicle is double locked.

Global closing (driver's door only)

WARNING



Take care when using global closing. In an emergency, press the button on the driver's door handle to stop.

When locking the vehicle, hold the button pressed for at least two seconds to close all windows and the sunroof.

Tailgate

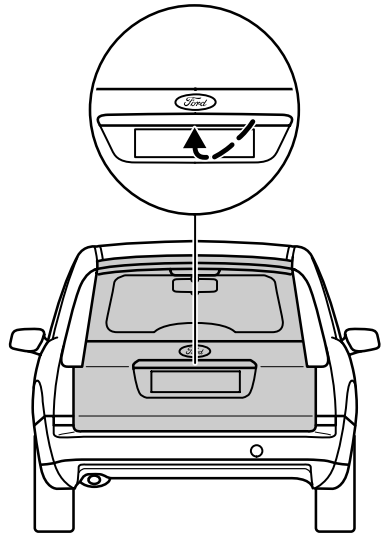

E78262

Note: If the passive key is located within the tailgate detection range, only the tailgate can be opened. The other doors will remain locked.

To open the luggage compartment, press the tailgate release switch.

PASSIVE KEY IN
LUGGAGE COMP.

E78493

Note: When the vehicle is locked, the tailgate cannot be closed and will pop back up if the passive key is located inside the luggage compartment.

Quick start

If a second valid passive key is located within the tailgate detection range, the tailgate can be closed.

See **Keyless entry** (page 45).

Assembling the spare key

The spare key can be used in the following ways:

- To open the bonnet.
- To lock and unlock the vehicle.
- To start the engine.

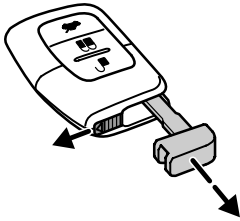

E78284

Remove the key blade from the passive key.

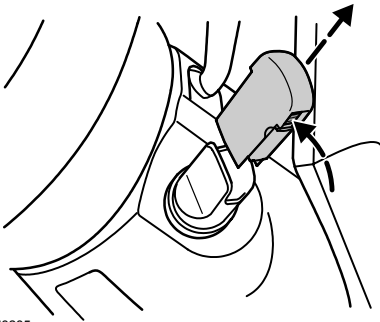

E78285

Push the button on the side of the ignition switch and remove the container.

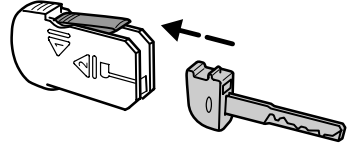

E78286

Insert the spare key blade into the container.

Starting the engine with the spare key

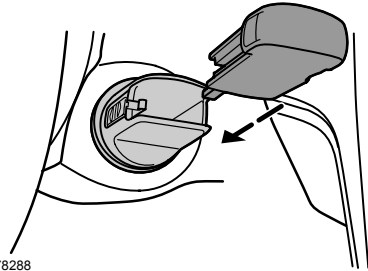

E78288

Note: Remember to remove the spare key from the ignition switch after switching off. If the spare key is in the ignition when the driver's door is opened, a warning tone will sound.

Insert the spare key into the ignition switch.

Push the ignition switch in and turn it to switch on the ignition and to start the engine.

**PASSIVE KEY
OUTSIDE CAR**

E78494

Quick start

If the engine is running and a passive key is no longer detected within the vehicle interior, **PASSIVE KEY OUTSIDE CAR** will appear in the information display and a chime will sound as soon as the door is closed.

If you no longer have a passive key, the vehicle can still be centrally locked one more time without a passive key. Once locked, the vehicle can only be unlocked using a valid passive key or spare key.

See **Starting the engine** (page 151).

Towing vehicles with the key free system

When the vehicle is towed:

- insert the spare key into the ignition switch.
- turn the ignition switch to position **II**.

See **Vehicle recovery** (page 207).

Airbag



E69213

WARNING

 To avoid the risk of death or serious injury, never use a rearward facing child restraint in the front, unless the air bag is off.

See **Child safety** (page 22).

See **Disabling the passenger airbag** (page 33).

Manual transmission

Reverse gear - 6-speed transmission

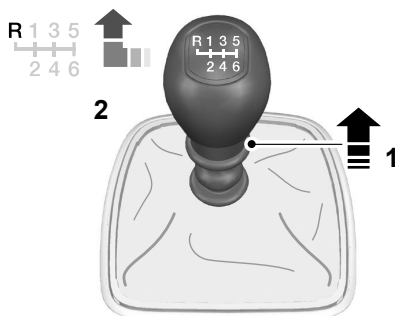

E75052

See **Manual transmission** (page 164).

Automatic transmission

Note: When the engine is started, the **brake pedal and the selector lever button** must be depressed before the selector lever can be moved from the park position **P**.

Quick start

See **Automatic transmission** (page 165).

Optional features

Adaptive front lighting system (AFS)

When dipped beam is switched on, the AFS adjusts the headlamp beam automatically depending on the vehicle direction and road speed.

See **Adaptive front lighting system (AFS)** (page 70).

Cooled glove compartment

The glove box can be cooled using air from the air conditioning system.

See **Glove box** (page 147).

Vehicle setup

The steering characteristics on vehicles with electro-hydraulic steering and the shifting behaviour of the Durashift CVT transmission can be adjusted using the information display.

See **Personalised settings** (page 108).

Stability control (ESP)

The ESP system provides enhanced traction and supports vehicle stability.

See **Stability control** (page 174).

Child safety

CHILD SEATS



E68916

WARNINGS

 Secure children that are less than 150 centimetres tall or less than 12 years of age in a suitable, approved child restraint, in the rear seat.

 Original text according to ECE R94.01: Extreme Hazard! Do not use a rearward facing child restraint on a seat protected by an air bag in front of it!

 Read and follow the manufacturer's instructions when you are fitting a child restraint.

 Do not modify child restraints in any way.

 Do not hold a child on your lap when the vehicle is moving.

 Do not leave unattended children in your vehicle.

 If your vehicle has been involved in an accident, have the child restraints checked by properly trained technicians.

Note: Mandatory use of child restraints varies from country to country.

A choice of ECE approved child restraints is available from your Ford Dealer. Ask for the child restraint that we recommend for your vehicle.

Child restraints for different mass groups

Use the correct child restraint as follows:

Baby safety seat



E68918

Secure children that weigh less than 13 kilogrammes in a rearward facing baby safety seat in the rear seat.

Child safety

Child safety seat

Secure children that weigh between 13 and 18 kilogrammes in a child safety seat in the rear seat.



E68920

CHILD SEAT POSITIONING

Child seat positions

Seating positions	Mass group categories				
	0	0+	I	II	III
	Up to 10 kg	Up to 13 kg	9-18 kg	15-25 kg	22-36 kg
	Baby safety seat	Baby safety seat	Child safety seat	Booster seat or cushion	Booster seat or cushion
Front passenger airbag ON	X	X	U ¹	U ¹	U ¹
Front passenger airbag OFF	U	U	U	U	U
Rear seats	U	U	U	U	U

U Suitable for universal category restraints approved for use in this mass group.







X Not suitable for children in this mass group.

U¹ Suitable for universal category child restraints approved for use in this mass group. However, we recommend that you secure children in a government approved child restraint, in the rear seat.

Child safety

BOOSTER CUSHIONS

WARNINGS

-  Do not install a booster seat or a booster cushion with only the lap strap of the seat belt.
-  Do not install a booster seat or a booster cushion with a seat belt that is slack or twisted.
-  Do not put the seat belt under your child's arm or behind its back.
-  Do not use pillows, books or towels to boost your child's height.
-  Make sure that your children sit in an upright position.
-  Secure children that weigh more than 15 kilogrammes but are less than 150 centimetres tall in a booster seat or a booster cushion.

Booster seat



E70710

We recommend that you use a booster seat that combines a cushion with a backrest. The raised seating position will allow you to position the shoulder strap of the adult seat belt over the centre of your child's shoulder and the lap strap tightly across its hips.

Booster cushion



E68924

ISOFIX ANCHOR POINTS

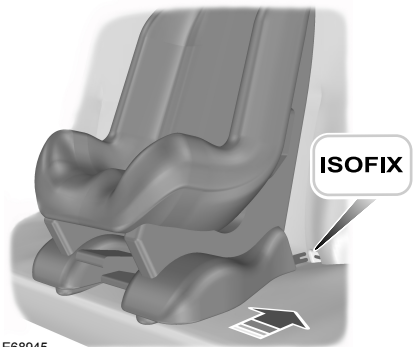

E68945

Child safety

WARNING

 Use only ISOFIX child seats we recommend.

You can fit ISOFIX child restraints using the ISOFIX anchor points.

The ISOFIX system comprises of two rigid attachment arms on the child restraint that attach to anchor points on the rear seats, where the cushion and backrest meet. Tether anchor points may also be fitted.

All except convertible

WARNING

 Use an anti-rotation device when using the ISOFIX system, e.g. support leg or top tether.

Attaching child safety seats with top tethers

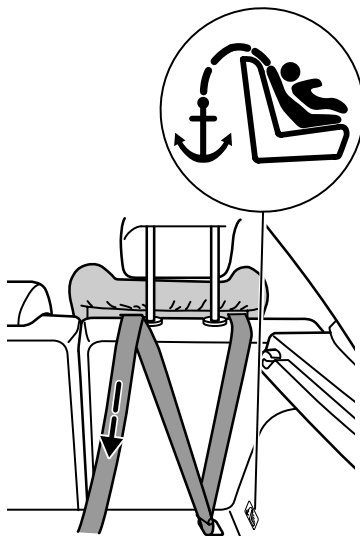

E78828

WARNING

 Do not attach a tether strap to anything other than the correct tether anchor point.

Route the tether strap to the anchor point. Tighten the tether strap to the manufacturer's instructions.

Child safety

CHILD SAFETY LOCKS

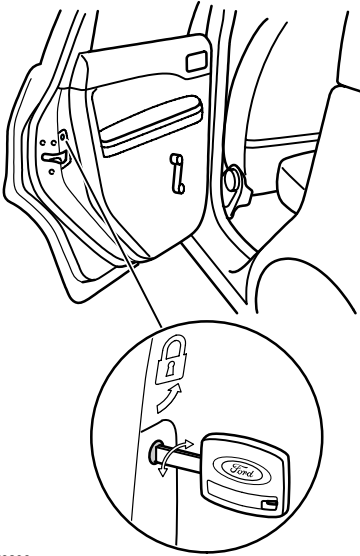

E78298

WARNING



When the child safety lock is activated, the door can only be opened from outside.

Turn the key in the rear door in the direction of the arrow to activate the lock. To deactivate the lock turn the key in opposite direction to the arrow.

Occupant protection

PRINCIPLE OF OPERATION

Airbags

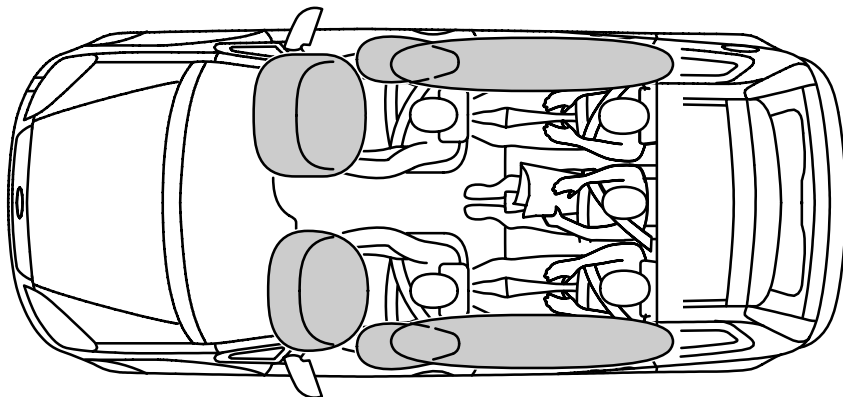

E78293

WARNING



Do not modify the front of the vehicle in any way as this can adversely affect airbag deployment.

Note: A loud bang will be heard when an airbag deploys and it is normal to see a cloud of harmless powdery residue.

The airbag system comprises the following:

- single-stage inflatable nylon bags (airbags) with gas generators
- side airbags
- curtain airbags
- seat belt pretensioners
- a seat belt reminder
- crash sensors.

- a warning lamp in the instrument panel.
- an airbag deactivation switch
- an airbag deactivation indicator in the instrument panel
- an electronic control and diagnostic unit.

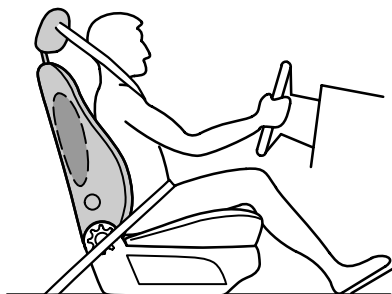



E72330

Occupant protection

WARNINGS

 Repairs to either of the front seat covers, the sensors attached to the seats as well as to the roof lining should only be carried out by properly trained technicians. Injuries may result if the side airbags are triggered inadvertently.

 Do not block, obstruct or cover the airbag because it may prevent proper deployment. Do not poke any sharp objects into the areas where airbags are fitted. This could damage the airbags.

 Do not use any accessory seat covers that are not specifically designed for seats with side airbags. These seat covers must be fitted by properly trained technicians.

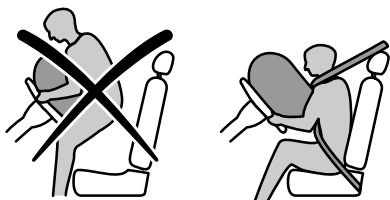

E66553

WARNING

 Always wear the seat belt and keep sufficient distance between the driver and the steering wheel. Only when the seat belt is used properly, can it hold the body in a position which allows the airbag to achieve its optimum effect. There is a risk of injury when the airbag deploys.

The seat and back must be set correctly for the airbags to be optimally effective. See **Sitting in the correct position** (page 138).

This is the ideal seating position for the driver and front passenger and helps reduce the risk of injury from sitting too close to an inflating airbag.

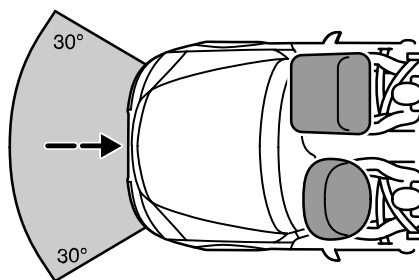

E72325

The front airbags activate during **significant collisions** which are either **frontal** or **up to 30 degrees** from the left or the right. The airbags inflate within a few thousandths of a second. They will deflate on contact with the front occupants thus cushioning forward body movement.

Occupant protection

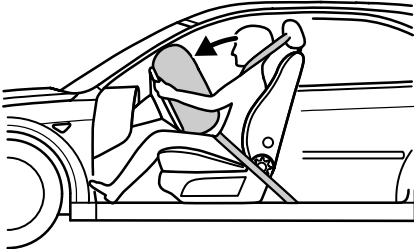

E72326

During minor collisions as well as overturns and rear or side collisions, the front airbag system will not be activated.

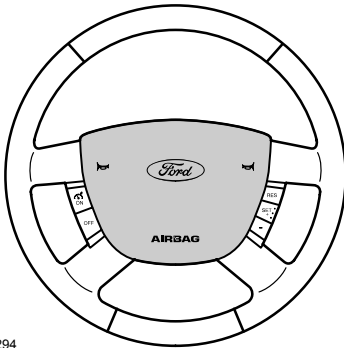

E78294

WARNINGS



Repairs to the steering wheel, steering column and airbag system should be carried out by properly trained technicians.



Always keep the areas in front of the airbags free. Never affix anything to or over these areas.

These areas should only be wiped with a damp cloth, never with a wet cloth.

Side air bags

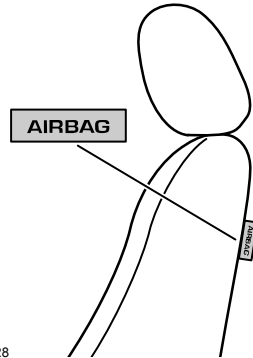

E72328

A label on the seatback indicates that side airbags are fitted. The side airbags are fitted on the side of the seatbacks of the front seats. In case of a severe lateral collision, the airbag on the side affected by the collision will be inflated.

The airbag will inflate between the door panel and occupant. Once the occupant's body contacts the airbag, the propellant escapes, thereby cushioning the impact.

The side airbags are not activated upon minor lateral collisions nor upon front or rear impacts.

Occupant protection

Curtain air bags

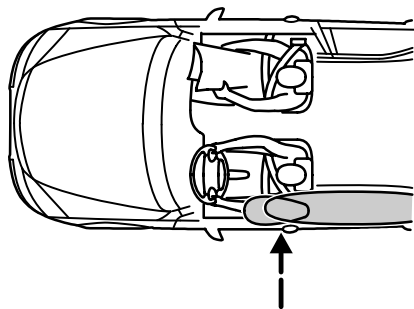





E72329

Moulded badges in the A- and B-pillar trims indicate that curtain air bags are fitted. The curtain airbags are fitted over the front and rear side windows inside the roof lining. In case of a severe lateral collision, the air bag on the side affected by the collision will be inflated.

The curtain air bags are not activated upon minor lateral collisions nor upon front or rear impacts.

Seat belts

WARNINGS

-  Use seat belts at all times.
-  Never use a seat belt for more than one person.
-  Avoid wearing thick clothing.
-  The seat belts should fit tightly around the body.

Seat belt pretensioner

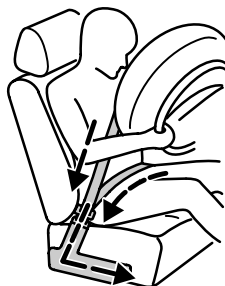

E72333

WARNING

 The belt pretensioners must not be removed. If the pretensioners are deployed during an accident, they must be replaced. Have the pretensioners serviced and disposed of by specially trained personnel only.

The restraint system, with belt pretensioners in the front seats, helps to reduce the risk of serious injury in a major frontal impact. During a serious crash the seat belts are pretensioned to help reduce slack in the belt. The safety belt pretensioner is a device which removes excess webbing from the safety belt system. When the safety belt pretensioner deploys, webbing from the lap and shoulder belt is tightened.

The belt pretensioner is not triggered in any side, rear or minor frontal collisions.

Occupant protection

FASTENING THE SEAT BELTS

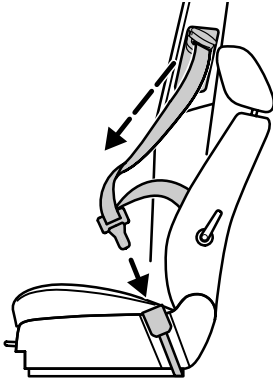

E78822

WARNING

 Insert the tongue into the buckle until a distinct click is heard, otherwise the seat belt will not be locked correctly.

Pull the belt out steadily. It may lock if pulled sharply or if the vehicle is on a slope.

To release the belt, press the red button on the buckle and let the belt rewind completely and smoothly.

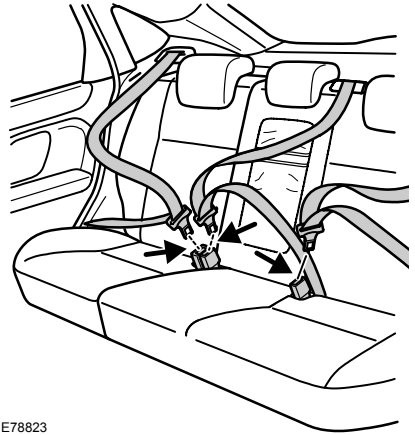

E78823

WARNING

 In order to ensure that the centre belt works properly, the rear seatback must be correctly engaged.

Make sure that each seat belt uses the correct buckle.

FocusST

WARNING

 When Recaro rear seats are fitted, the rear seats may be occupied by two passengers only. A centre seat belt is not fitted.

Occupant protection

SEAT BELT HEIGHT ADJUSTMENT

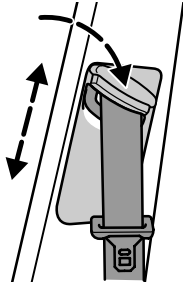

E78081

Press the locking control on the height adjuster and move the pivot so that the belt rests across the centre of the shoulder.

Lifting the slider slightly while pressing the locking control makes it easier to release the locking mechanism.

USING SEAT BELTS DURING PREGNANCY

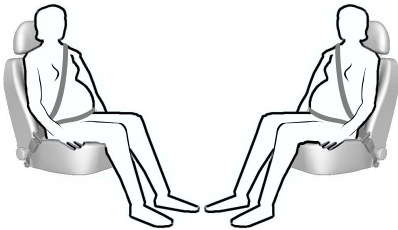

E68587

WARNING

 Position the seat belt correctly for your safety and that of your unborn child. Do not use only the lap strap or the shoulder strap.

Position the lap strap comfortably across your hips and low beneath your pregnant abdomen. Position the shoulder strap between your breasts, above and to the side of your pregnant abdomen.

ROLLOVER BARS

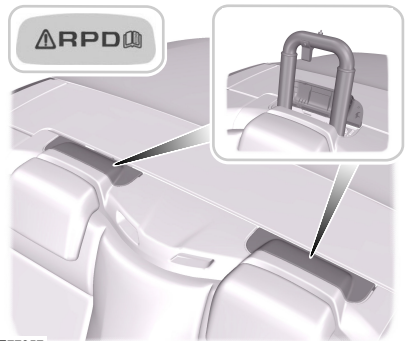

E77957

WARNINGS

 Keep the areas around the rollover bar covers free from obstruction.

 Do not attempt to reset the rollover protection system if it deploys.

The rollover protection system comprises:

Occupant protection

- two inverted U-shaped bars
- rollover sensors.

The rollover bars will deploy when the sensors determine that a risk of rollover is imminent.

Have repairs to the rollover protection system carried out by properly trained technicians.

DISABLING THE PASSENGER AIRBAG

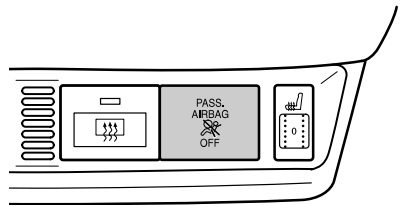
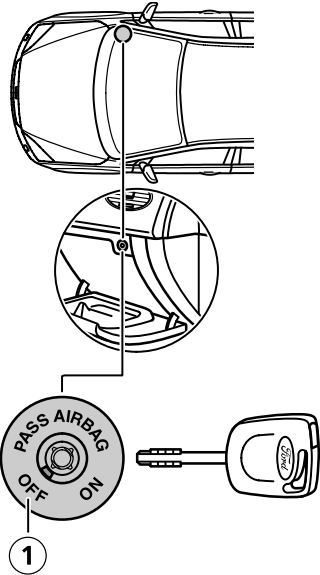

E78824

Occupant protection

WARNING

 To avoid the risk of death or serious injury, NEVER use a rearward facing child restraint in the front, unless the airbag is OFF.

If individual circumstances require you to fit a child seat or restraint on a seat protected by an operational airbag in front of it, your vehicle is equipped to allow fitting of a passenger airbag deactivation switch operated by a key.

The key switch will be fitted in the glove box with an airbag deactivation indicator in the instrument panel.

To use a child restraint in the front, make sure that the key switch is turned to the **OFF** position **1**.



E69213

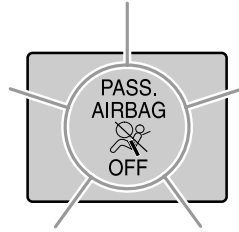

E78825

When the ignition is switched on (position **II**), check that the airbag deactivation indicator is illuminated.



E69210

If the airbag warning lamp in the instrument cluster illuminates intermittently, it means there is a malfunction. Remove the child restraint from the front. Have the system checked by a Ford dealer for your own safety.

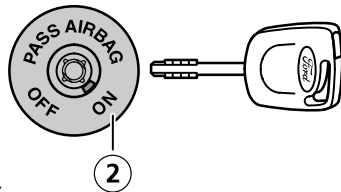

E78297

WARNING

 To ensure the adult restraint system performs as intended, make sure the airbag is ON.

Occupant protection

After removing the child restraint from the front, make sure that the key switch is turned to the **ON** position **2**.

Keys and remote controls

GENERAL INFORMATION ON RADIO FREQUENCIES

See **Type approvals** (page 262).

CAUTION

! The radio frequency used by your remote control can also be used by other short distance radio transmissions (e.g. amateur radios, medical equipment, wireless headphones, remote controls and alarm systems). If the frequencies are jammed, you will not be able to use your remote control. You can lock and unlock the doors with the key.

Note: You could unlock the doors if you press the buttons on the remote control unintentionally.

The operating range between your remote control and your vehicle varies depending on the environment.

PROGRAMMING THE REMOTE CONTROL

A maximum of eight remote controls can be programmed (including the ones delivered with the vehicle). The remote controls must remain inside the vehicle during the programming procedure. Fasten the front seat belts and close all doors to ensure that conflicting chimes do not sound during programming.

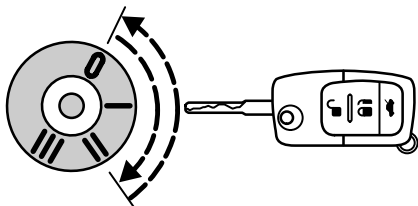

E78253

- To programme new remote controls turn the ignition key to position **II** four times within six seconds.
- Turn the ignition to position **O**. A tone sounds to indicate that it is now possible to programme the remote controls for ten seconds.

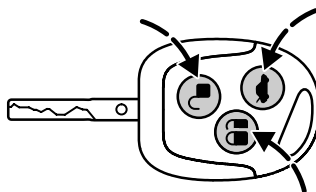
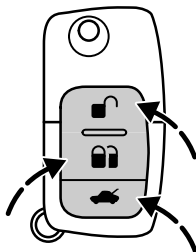

E78254

Keys and remote controls

- Press any button on a new remote control. A tone will sound as confirmation. Repeat this last step for all your remote controls, including your original. Do not remove the key from the ignition when pressing the button on this remote control.
- Switch the ignition back on (position II) or wait for ten seconds without programming another remote control to end the key programming. Only the remote controls which you have just programmed are now able to lock and unlock the vehicle.

Reprogramming the unlocking function

You can change the unlocking function so that pressing the unlock button once deactivates the central locking or double locking, disarms the anti-theft alarm system and unlocks only the driver's door. Pressing the unlock button twice within three seconds also unlocks the passengers' doors.

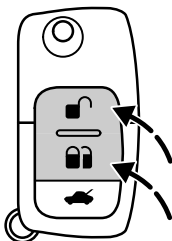

E78255

In order to re-programme the function, press and hold the unlock and lock buttons simultaneously for at least four seconds with the ignition switched off. The direction indicators will flash twice to indicate that the unlocking function has been successfully re-programmed.

Pressing and holding both buttons simultaneously for at least four seconds again will change the function back.

CHANGING THE REMOTE CONTROL BATTERY

If the range of the transmitter in the remote control decreases gradually, the battery (type 3V CR 2032) should be replaced.

Remote control type 1

First, press the button to release the key blade.

Passive key

Remove the spare key.

Keys and remote controls

Opening the container

Remote control type 1

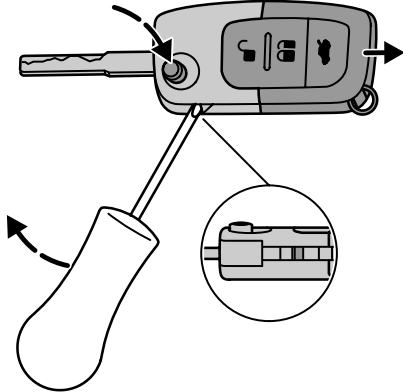

E78256

- Insert a screw driver as far as possible into the slot at the side of the remote control and push it towards the key blade to release the container from the key blade.

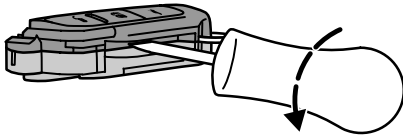

E78257

- Insert the screw driver into the opening at the side of the container and rotate it to start opening the container.

Remote control type 1 and passive key

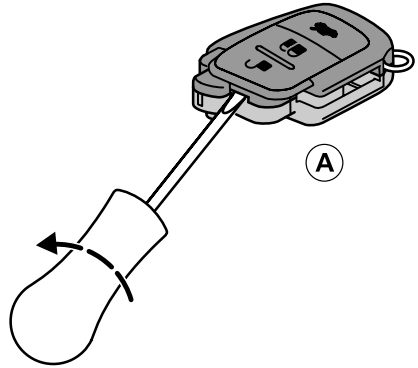

A

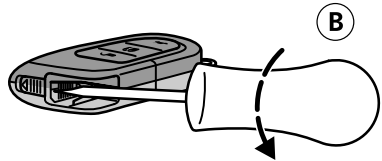

B

E78258

- A Remote control
- B Passive key

- Insert the screw driver into the opening at the front of the container and rotate it to open the container completely. Be careful not to lose the key ring.

Keys and remote controls

Remote control type 2

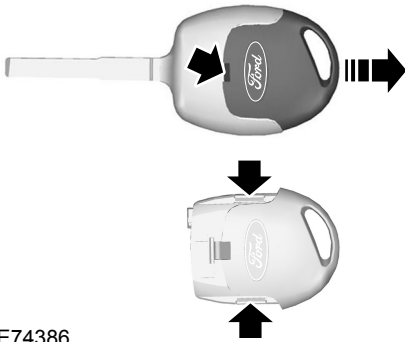

E74386

- Carefully separate the transmitter unit from the key using a screwdriver at the recess on the back.
- Open the transmitter unit by separating the retaining clips on the sides with the screwdriver.

Replacing the battery

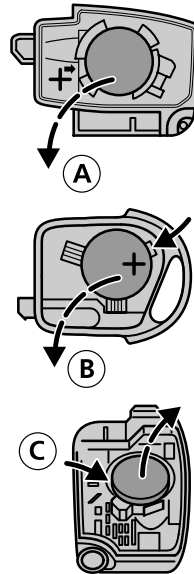

E78259

- A Type 1
- B Type 2
- C Passive key

- Insert the screw driver into the opening marked with an arrow and carefully prise out the battery. Take care not to touch the battery contacts or the printed circuit board.
- Insert a new battery. The plus contact of the battery (marked with a +) must face upwards.

Keys and remote controls

Reassembling the container

Snap the two halves of the housing together.

Remote control type 1

Assemble the key blade until it snaps onto the container.

Remote control type 2

Snap the transmitter unit back onto the key.

Passive key

Insert the spare key blade into the passive key until it clicks into place.

Locks

LOCKING AND UNLOCKING

Doors

Locking and unlocking from the outside

Left-hand drive

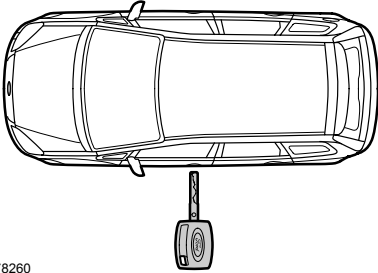

E78260

Right-hand drive

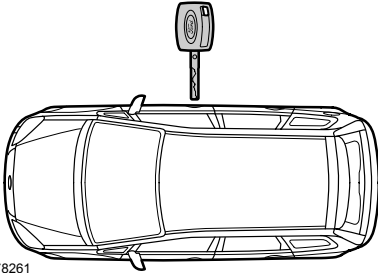

E78261

Note: Only vehicles without remote control are equipped with a lock cylinder in the passenger's door.

All doors can be locked and unlocked from the outside with the key at the driver's door.

On vehicles without remote control, they can also be locked and unlocked at the front passenger's door.

Locking and unlocking from the inside

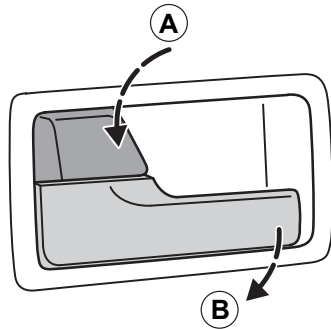

E72194

Note: On vehicles without remote control, all doors can also be locked using the locking button on the front passenger's door.

When inside the vehicle, all doors can be locked with the locking button **A** on the driver's door and unlocked using the door handle **B**. To lock the front passenger's door and the rear doors individually, depress the locking button and close the door when leaving the vehicle.

Locks

Tailgate

Opening the tailgate

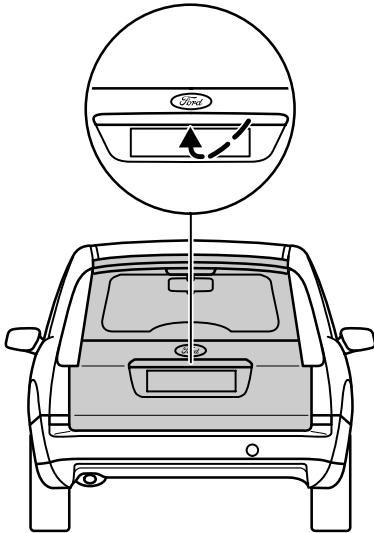

E78262

Note: If there is a cut in the power supply e.g. the battery is disconnected, it is not possible to open the tailgate. To open the tailgate, the vehicle must first be unlocked with the key or remote control.

To open the luggage compartment, press the switch. The driver's door must be unlocked.

Closing the tailgate

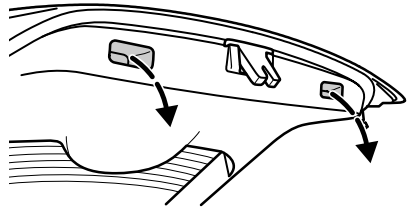

E78263

A recessed grip is incorporated inside the tailgate to facilitate closing.

Central and double locking

Left-hand drive

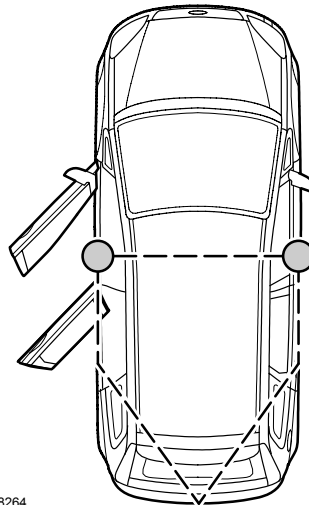

E78264

Locks

Right-hand drive

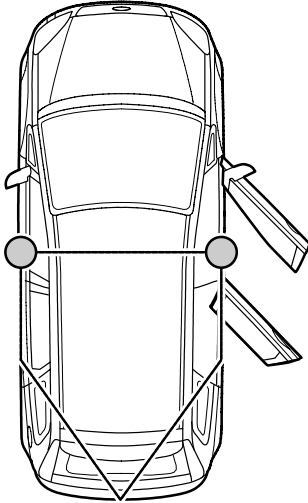

E78265

WARNING

 Double locking should not be activated when persons are inside the vehicle.

Note: Only vehicles without remote control are equipped with a lock cylinder in the passenger's door.

The central locking system can be activated from the driver's door. It operates only when the front doors are closed. It is activated from the outside with the key or remote control, or from inside by depressing the locking button on the driver's door handle.

On vehicles without remote control, it can also be activated from outside with the key at the passenger's door or using the locking button on that door.

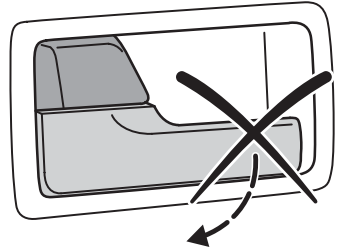

E72198

Double locking is an additional theft protection feature which prevents the vehicle's doors being opened from inside the vehicle. Double locking is possible only if the front doors are closed.

Unlocking the vehicle

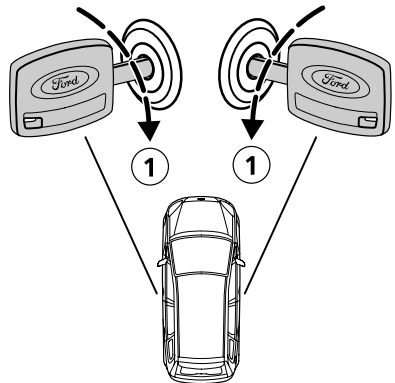

E78266

Locks

With the key: Turn the key in the driver's or front passenger's door to position **1**.

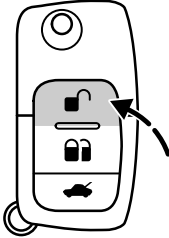

E78267

WARNING

 If a failure occurs in the vehicle's electrical system the driver's door can still be individually unlocked with the key.

With the remote control: Press the unlock button once.

One long flash of the direction indicators confirms that all the doors, the tailgate and the fuel filler flap have been unlocked and that the anti-theft alarm system has been disarmed.

Automatic relocking

To prevent the vehicle being left unlocked inadvertently, central locking and the anti-theft alarm system will be reactivated automatically 45 seconds after the unlock button is pressed if the following occurs during this period:

- No door is opened.
- The luggage compartment is not opened.
- The ignition is not switched on.

Unlocking the tailgate

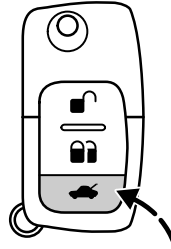

E78268

To unlock only the tailgate when the vehicle is locked, press the unlock button twice within three seconds.

Locking the vehicle

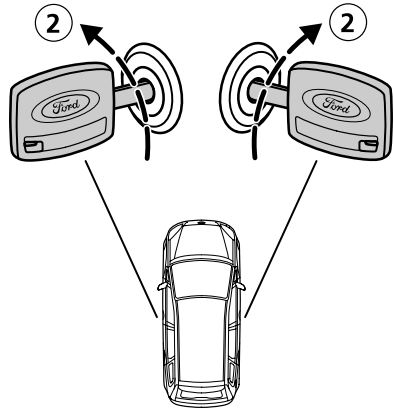

E78269

To activate central locking and arm the anti-theft alarm system:

With the key: Turn the key in the driver's or front passenger's door to position **2**.

Locks

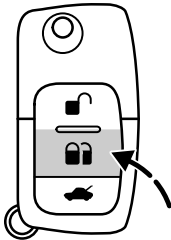

E78270

With the remote control: Press the lock button once.

On vehicles without double locking, the direction indicators will flash twice as confirmation.

Double locking the vehicle

Note:

Left-hand drive

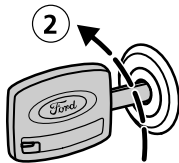

E78271

Right-hand drive

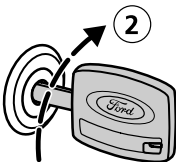

E78272

With the key: Turn the key in the driver's door to position **2** twice within three seconds.

CAUTION

! **Convertible only** - Always double lock your vehicle when the convertible top is open.

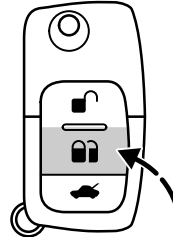

E78270

With the remote control:

- **All except convertible** - Press the lock button twice within three seconds.
- **Convertible only** - Press the lock button once.

The direction indicators will flash twice as confirmation.

KEYLESS ENTRY

General information

The key free system allows the driver to operate the vehicle without the use of a key or remote control.

Locks

The advantages of the key free system are:

- the vehicle can be locked and unlocked without having to insert a key into the door lock or press any buttons on a remote control.
- the engine can be started without the need to insert a key into the ignition. See **Starting the engine** (page 151).

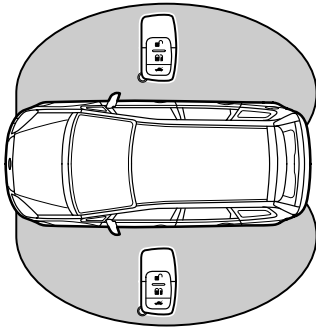

E78276

Note: If the door handles are pulled repeatedly during a short period of time without the presence of a valid passive key, the system might become inoperable for a certain time.

To unlock or lock the vehicle, the passive key must be located within one of the three external detection ranges. These are located approximately one and a half metres from the driver's and front passenger's door handles and the tailgate.

Passive key

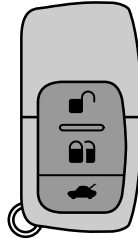

E78277

WARNING

 Do not store the passive key with metal objects or electronic devices such as mobile phones as this could cause interference with the key free system.

The vehicle is operated by means of a passive key. See **Type approvals** (page 262). The passive key can also be used as a remote control. See **Locking and unlocking** (page 41).

Spare key

A spare key is provided for the following situations:

- If the passive key frequencies are jammed.
- If the passive key battery is flat.

Locks

- If the key free function has been deactivated using the information display.
- When the vehicle is being towed.
- To reactivate a deactivated passive key.

The spare key can be used in the following ways:

- To open the bonnet. See **Opening and closing the bonnet** (page 210).
- To lock and unlock the vehicle.
- To start the engine. See **Starting the engine** (page 151).

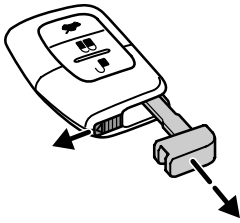

E78284

Slide the release slider in the direction of the arrow and pull out the key blade with your thumb.

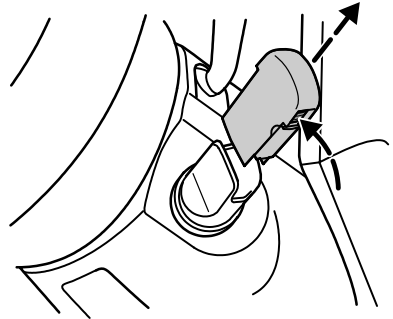

E78285

Push the button on the side of the ignition switch and pull out the container.

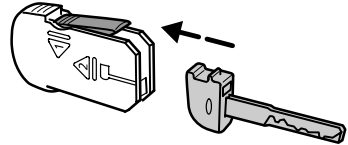

E78286

Insert the spare key blade into the container until it clicks. Make sure the blade is inserted the right way up.

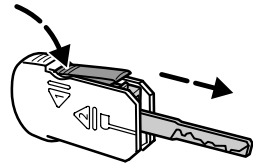

E78287

To release the spare key blade from the container, press the upper part of the button.

Insert the spare key blade back into the passive key until it clicks.

Locks

Insert the container back into the ignition switch.

Disabled passive keys

Note: All your passive keys will be enabled, regardless of whether they are located inside the vehicle or not.

If one or more passive keys are left inside the vehicle interior when it is locked, the passive keys inside the vehicle will be disabled. In order to use these passive keys again, they have to be enabled.

To enable all your passive keys:

Using an enabled passive key, depress the clutch pedal (manual transmission) or brake pedal (automatic transmission), push the ignition switch in and turn it to position **II**.

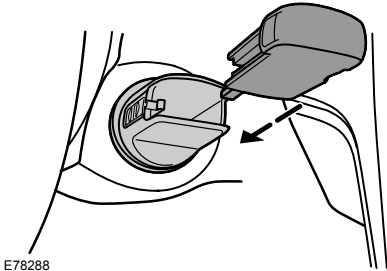

E78288

If you only have a disabled passive key:

Insert the spare key into the ignition switch.

Push the ignition switch in and turn it to position **II**.

As soon as the ignition is turned to position **II**, all your passive keys will be enabled.

Unlocking the vehicle

Note: If the vehicle is not unlocked for longer than five days, the key free system will enter an energy-saving mode. This is to prevent the battery from discharging. When the vehicle is unlocked while in this mode, the reaction time of the system may be a little longer than normal. Unlocking the vehicle once will deactivate the energy-saving mode.

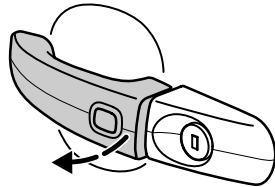

E78278

Pull any door handle to unlock all the doors and the tailgate and disarm the alarm.

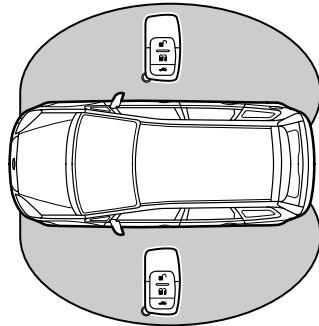

E78279

Locks

Note: A valid passive key must be located within the detection range of that door.

One long flash of the direction indicators confirms that all the doors, the tailgate and the fuel filler flap have been unlocked and that the alarm has been disarmed.

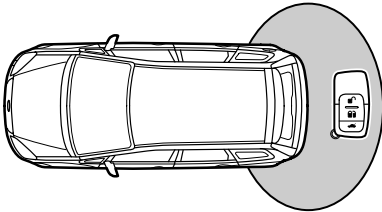

E78280

If the passive key is located within the tailgate detection range, only the tailgate can be opened. The other doors will remain locked.

Unlocking only the driver's door

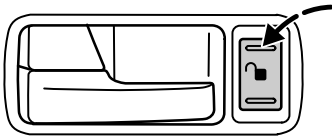

E78281

If the unlocking function is reprogrammed so that only the driver's door is unlocked (See **Programming the remote control** (page 36).), note the following:

If the driver's door is the first door which is opened, the other doors and the tailgate will remain locked. All the other doors can be unlocked from inside the vehicle by pressing the unlock button next to the driver's door handle. Doors can be unlocked individually by pulling the interior door handles on those doors.

If the front passenger's door or one of the rear doors is the first door which is opened, **all** the doors and the tailgate will be unlocked.

Tailgate

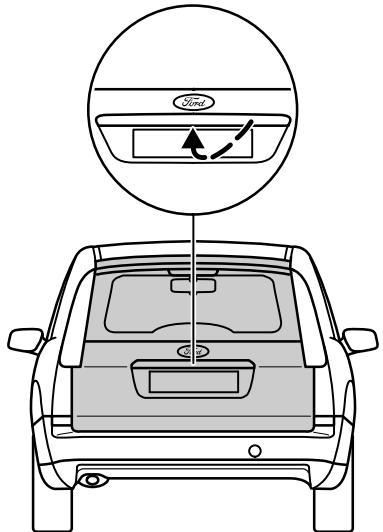

E78283

Locks

Note: The tailgate cannot be closed and will pop back up if the passive key is located inside the luggage compartment. **PASSIVE KEY IN LUGG. COMP.** will appear in the information display.

Note: If a second valid passive key is located within the tailgate detection range, the luggage compartment can be closed.

To open the luggage compartment, press the tailgate release switch.

Locking the vehicle

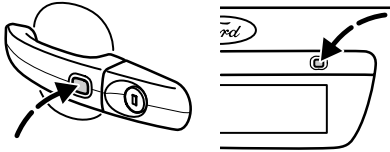

E78282

WARNING

 The vehicle does not lock itself automatically. If no locking button is pressed, the vehicle will remain unlocked.

Note: Before leaving the vehicle, ensure that the ignition switch is pulled out. See **Ignition switch** (page 151).

Note: A valid passive key must be located within the detection range of the respective door. If locking from the tailgate, the passive key must be within the tailgate detection range.

Note: Once activated, the vehicle will remain locked for approximately three seconds, even if the passive key is within the detection range during this delay period. This is to allow you to pull a door handle and check if the vehicle is locked. When the delay period is over, the doors can be opened again, provided the passive key is within the respective detection range. The delay period can be set to zero by an expert.

Note: If a passive key is left inside the vehicle **PASSIVE KEY LEFT INSIDE** appears in the information display. Remove the passive key from the vehicle interior. All passive keys left inside the vehicle when it is locked will be disabled.

To activate central locking and arm the alarm:

- Press the locking button on one of the front doors or the tailgate once.
- On vehicles without double locking, the direction indicators will flash twice as confirmation.

To activate double locking, to arm the alarm and the interior sensors:

- **All except convertible** - Press the locking button on one of the front doors or the tailgate twice within three seconds.
- **Convertible only** - Press the locking button on one of the front doors or the tailgate once.

The direction indicators will flash twice as confirmation.

Locks

Deactivating the key free function

The key free function can be deactivated using the information display. See **Information displays** (page 104).

Once it is deactivated:

- the vehicle can only be locked and unlocked using the spare key in the lock cylinder on the driver's door or using the buttons on the passive key.
- the engine can only be started with the spare key.

GLOBAL OPENING AND CLOSING

Note: The global opening and global closing feature will open and close the windows automatically only on vehicles equipped with four electric windows and on 3-door models equipped with the feature. The sunroof can always be opened and closed using this feature, regardless of the number of electric windows equipped.

Note: Global closing will only operate if the memory has been set correctly for each window. See **Electric windows** (page 86).

Global opening

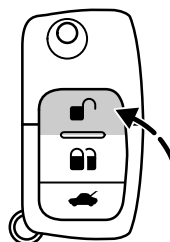
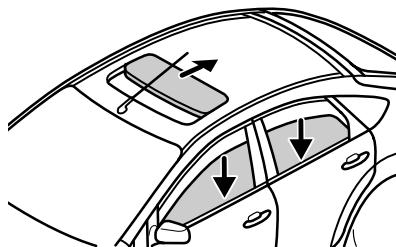

E78813

To open all the windows and the sunroof, press and hold the unlock button for at least three seconds. Pressing either the lock button or the unlock button again stops the opening function. During global opening, the sunroof will always open by sliding back under the roof.

Locks

Global closing

Vehicles without the key free system

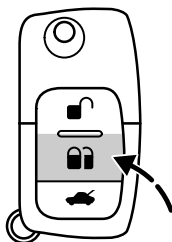
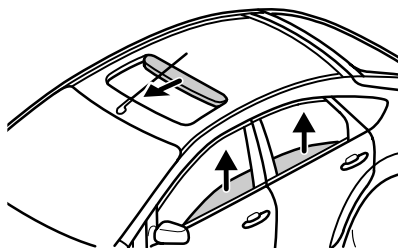

E78814

WARNING

 Take care when using global closing. In an emergency, press a button immediately to stop.

To close all the windows and the sunroof, press and hold the lock button for at least two seconds. Pressing any button again stops the closing function. The anti-trap function is also active during global closing. See **Electric windows** (page 86). See **Electric sunroof** (page 135).

Vehicles with the key free system

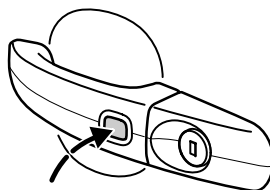

E78275

WARNING

 Take care when using global closing. In an emergency, press the button on the driver's door handle to stop.

Note: Global closing can be activated using the locking button on the driver's door handle. Global opening and closing can also be activated using the buttons on the passive key.

When locking the vehicle, hold the button pressed for at least two seconds to close all windows and the sunroof.

Engine immobiliser

PRINCIPLE OF OPERATION

The engine immobiliser is a theft protection system that prevents someone from starting the engine with an incorrectly coded key.

CODED KEYS

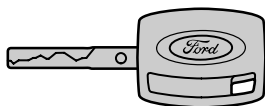

E78289

Your vehicle is supplied with coded keys.

Replacement keys must be recoded together with your other keys.

In case of loss, replacement keys are available from Ford Dealers by stating the key number shown on the tag provided with the original keys.

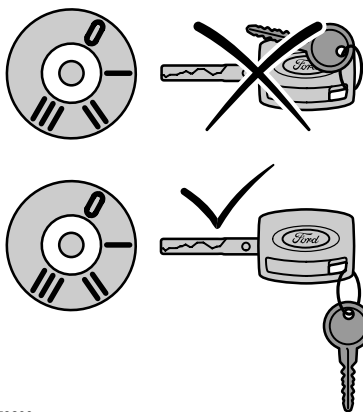

E78290

Note: To ensure a trouble-free data exchange between the vehicle and key, do not shield the keys with any metal objects.

Key with remote control

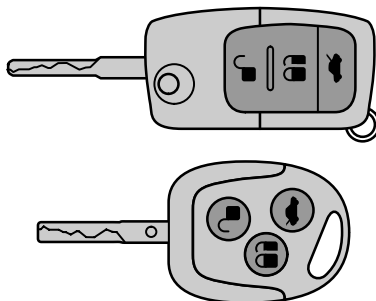

E78291

The transmitter is integrated into the key.

Engine immobiliser

Opening and closing the key blade



E74382

To open the key blade, press the button. To close, press the button and swivel the blade back into the container until it clicks.

ARMING THE ENGINE IMMOBILISER

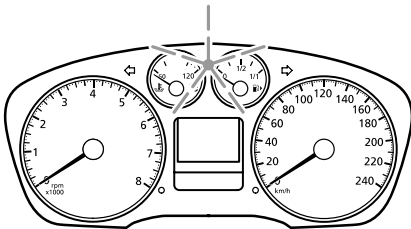

E78292

The system is armed five seconds after switching off the ignition. The indicator will **flash** every two seconds.

DISARMING THE ENGINE IMMOBILISER

Switching on the ignition disarms the system if the correct code is recognised. The indicator **illuminates** for approximately three seconds and then **extinguishes**.

If the indicator illuminates constantly for one minute or flashes for approximately one minute and then repeatedly at irregular intervals, the system did not recognise the key code or a system fault is present. Remove the key and try again.

If the engine does not start, a system malfunction has occurred. Have the system checked by an expert immediately.

Alarm

ARMING THE ALARM

The system is armed as soon as the vehicle is locked and acts as a deterrent to unauthorised persons who attempt to open the doors, bonnet or luggage compartment, or remove the audio system.

The alarm sounds for 30 seconds if an unauthorised person opens a door, the luggage compartment or the bonnet. The hazard flasher lights will flash for five minutes.

Any attempt to start the engine without a valid key or to remove the audio system sounds the alarm again.

Automatic arming delay

The 20 seconds arming delay begins when the bonnet, luggage compartment and all doors are closed.

Interior sensors



E71401

WARNING

 This system functions correctly only if all windows and the sunroof are completely closed. In addition to this, the sensors located in the interior lamp unit must not be covered up. The system should not be activated if any persons, animals or other moving objects are inside the vehicle.

Note: The interior sensors will not operate if the convertible top is open.

This system acts as a deterrent against unauthorised intrusion by sensing any movement within the vehicle.

Unauthorised entry into the vehicle's interior will trigger the alarm in the same way as the anti-theft system.

The sensors are located in the interior lamp unit.

Convertible only

The interior sensors are automatically disabled if the convertible top is open.

All except Britain and Ireland

The interior sensing alarm is armed together with the double locking system.

Britain and Ireland only

The interior sensing alarm is armed together with the central locking system.

To deactivate the interior sensors:

Alarm

Vehicles without keyless entry system

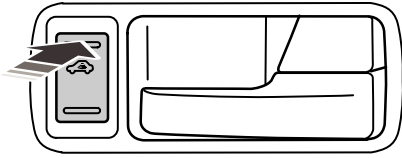

E80555

Press the upper part of the switch next to the driver's door handle.

Vehicles with keyless entry system

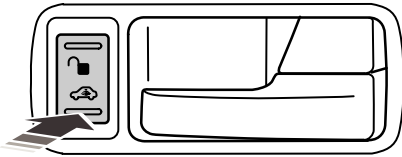

E80556

Press the lower part of the switch next to the driver's door handle.

DISARMING THE ALARM

The anti-theft alarm system can be deactivated at any time – even when the alarm is sounding – by unlocking the vehicle from the outside.

The anti-theft alarm system for the tailgate is deactivated if the tailgate is unlocked using the button on the remote control or passive key. On vehicles with the Key Free System, it is deactivated if a passive key is located within the tailgate detection range when the tailgate is opened.

After closure, the alarm is once again armed.

Britain and Ireland only

If the vehicle is unlocked using the key or the spare key for the keyless entry system, a 12 second delay chime starts as soon as the driver's door is opened. The alarm should be deactivated during this period.

Vehicles without keyless entry system

To deactivate the alarm, insert the key into the ignition and turn it to position **II**.

Vehicles with keyless entry system

The alarm should be deactivated in **one** of the following ways:

- If a valid passive key is located within the vehicle interior, depress the clutch pedal (manual transmission) or brake pedal (automatic transmission), push the ignition switch in and turn it to position **II**.
- Insert the spare key into the ignition switch, push the ignition switch in and turn it to position **II**.
- Press the unlock button on the passive key.

Steering wheel

ADJUSTING THE STEERING WHEEL

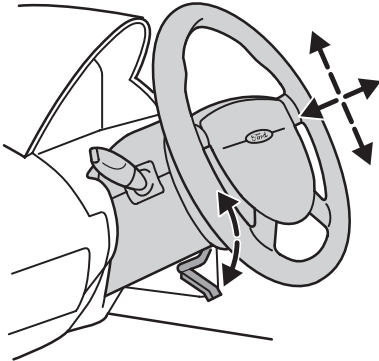

E70358

WARNING



Never adjust the steering wheel when the vehicle is moving.

Release the locking lever to adjust the height of the steering wheel and its distance from the driver.

Return the lever to its original position to secure the wheel.

See **Sitting in the correct position** (page 138).

HORN

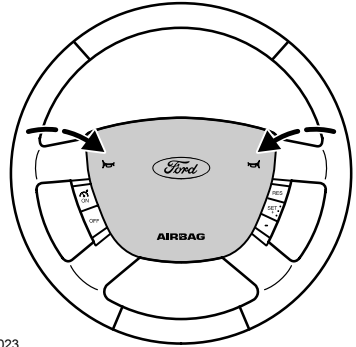

E78023

The horn can also be operated when the ignition is off.

AUDIO CONTROL

Select radio, CD or cassette mode on the audio unit.

The following functions can be operated with the remote control:

Volume

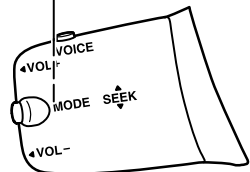
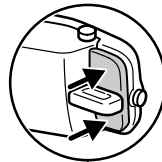

E78046

Steering wheel

Volume up: Press the top button on the back of the remote control.

Volume down: Press the bottom button on the back of the remote control.

Seek

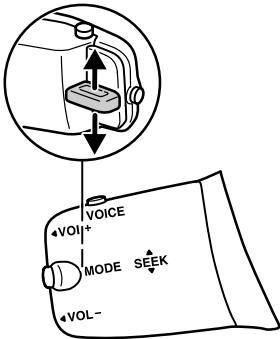

E78047

Move the lever up or down:

- In **radio mode**, this will locate the next radio station up or down the frequency band.
- In **CD mode**, it will select the next or previous track.

Mode

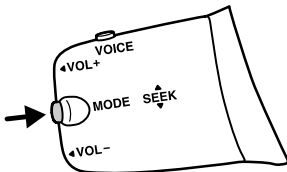

E78048

Briefly press the button on the side:

- In **radio mode**, this will locate the next pre-set radio station.
- In **CD mode**, this will select the next CD if a CD changer is fitted.
- In **all modes** to abort a traffic message during broadcasting.

Press and hold the button on the side:

- In **radio mode** to change the waveband.

VOICE CONTROL

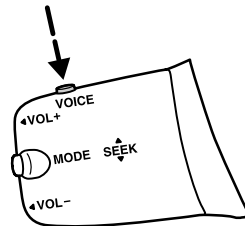

E78049

To select or deselect voice control, press the button on the top.

For further information see the separate handbook.

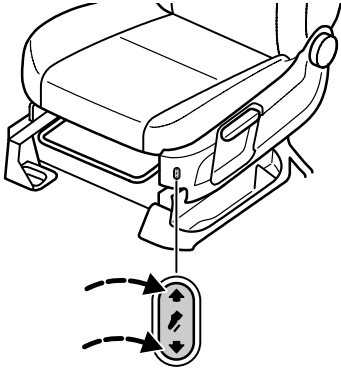

Pedals

ADJUSTING THE PEDALS



E78045

WARNINGS

-  Never adjust the pedals when the vehicle is moving.
-  When a floor mat is fitted, the pedals may get caught on the mat. When using floor mats, always ensure that there is enough clearance for the pedals to move.

Press the upper part of the switch to move the pedals towards the driver.

Press the lower part of the switch to move the pedals away from the driver.

See **Sitting in the correct position** (page 138).

Wipers and washers

WINDSCREEN WIPERS

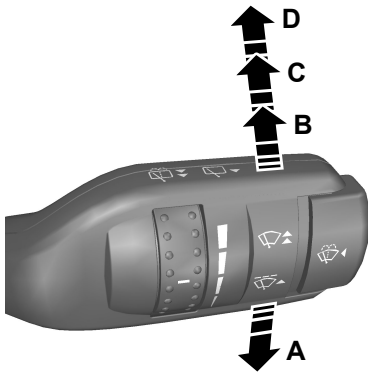

E71012

- A Single wipe
- B Intermittent wipe or autowipers
- C Normal wipe
- D High speed wipe

Intermittent wipe

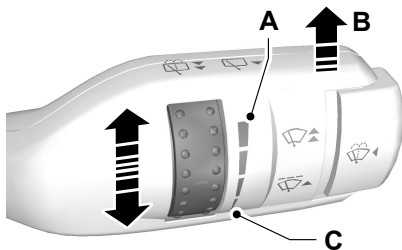

E71013

- A Long wipe interval
- B Intermittent wipe
- C Short wipe interval

The rotary control can be used to adjust the intermittent wipe interval.

Autowipers

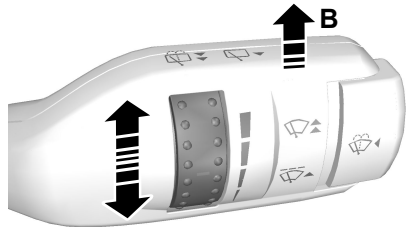

E71014

WARNINGS

 Replace the wiper blades as soon as they begin to leave bands of water and smears or when they do not completely remove water from the windscreen. If the blades are not replaced, the rain sensor will continue to detect water on the windscreen. This will result in the wipers continuing to operate although the majority of the windscreen is dry.

 In icy conditions, make sure that the windscreen has been fully defrosted before selecting autowipers.

 Switch off the autowipers before entering a car wash.

Wipers and washers

Note: The autowipers feature is intended for use during wet weather conditions only. It should not be selected in dry weather conditions as the system is very sensitive to objects such as dirt, mist or flies hitting the windscreen near the rain sensor. This may cause the wipers to wipe even though the screen is mostly dry.

Note: The autowipers function should not be selected when it is snowing or foggy, or when the roads have been salted. In these weather conditions, select position **A**, **C** or **D**, if necessary.

When the lever is moved to position **B** with the ignition switched on, the wipers will cycle once regardless of whether the front screen is wet or dry.

Depending on the equipment fitted, when the ignition is switched on with the lever already in position **B**, the wipers will not cycle until water is detected on the windscreen. Alternatively, move the lever to another position and then back to **B**, or operate the washer.

Thereafter, the rain sensor will continuously measure the amount of water on the windscreen and adjust the speed of the front wipers automatically (single wipe, intermittent, normal or high speed wipe).

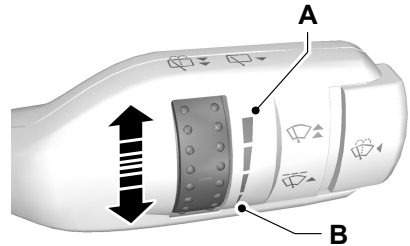

E71015

- A Low sensitivity
- B High sensitivity

- A. The wipers will only wipe when a larger amount of water is detected on the windscreen
- B. The wipers will wipe even if only a small amount of water is detected on the windscreen.

Six settings are available from low to high sensitivity.

Automatic wiper system

Some models without autowipers are fitted with a speed-dependent front screen wiper system.

When the vehicle is slowed to walking speed or is brought to a standstill, the wiper speed will automatically switch to the next lower wiper speed setting.

When the vehicle speed is increased, the wiper speed will return to the manually-chosen setting.

Moving the wiper lever when the system is operating will switch off the system.

Wipers and washers

If the vehicle is again slowed to walking speed or is brought to a standstill, the system is reactivated.

WINDSCREEN WASHERS



E71016

WARNING



Do not operate the washer for more than 10 seconds at a time, and never when the reservoir is empty.

While the button at the end of the lever is pressed the washer will work in conjunction with the wipers.

After releasing the button, the wipers operate for a short time.

REAR WINDOW WIPER AND WASHERS

Intermittent wipe

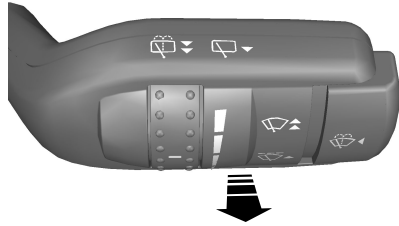

E71017

Pull the lever towards the steering wheel.

Reverse gear wipe

The rear wiper will be activated automatically when selecting reverse gear if:

- the rear wiper is not already switched on,
- the wiper lever is in position **A**, **B**, **C** or **D** and
- the front wiper is operating (when set to position **B**).

The rear wiper will follow the front wiper interval (at intermittent or normal speed).

Wipers and washers

Rear window washer

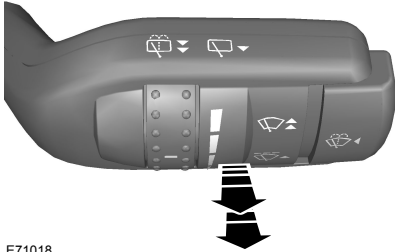

E71018

WARNING



Do not operate the washer for more than 10 seconds at a time, and never when the reservoir is empty.

While the lever is pulled towards the steering wheel the washer will work in conjunction with the wipers.

Once the wash/wipe cycle is completed, the wipers will pause and then perform one more wipe to clear the windscreen.

After releasing the lever, the wipers operate for a short time.

ADJUSTING THE WINDSCREEN WASHER JETS

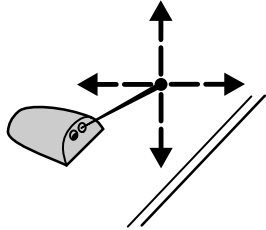

E73425

The eye ball jets can be adjusted precisely using a pin.

HEADLAMP WASHERS

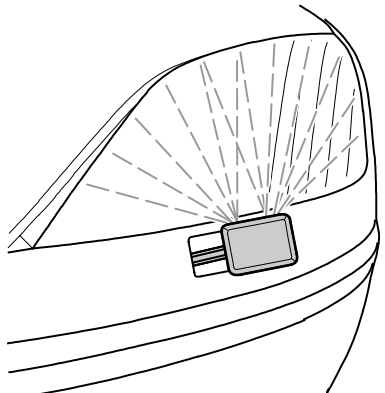

E73427

Wipers and washers

WARNING

 Do not operate the washer for more than 10 seconds at a time, and never when the reservoir is empty.

Note: On some models, to prevent the washer fluid reservoir from becoming empty too quickly, the headlamp washer will not be activated with every press of the button. For a period of ten minutes after activation, the washer will only be activated again with every fourth press of the button.

The headlamp washers operate when the exterior lights are switched on and the windscreen washer is used. The system is supplied from the washer fluid reservoir.

CHECKING THE WIPER BLADES

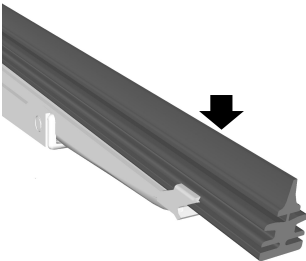

E66644

Run the tip of your fingers over the edge of the blade to check for roughness.

Clean the wiper blade lips with water applied with a soft sponge.

CHANGING THE WIPER BLADES

Windscreen wiper blades

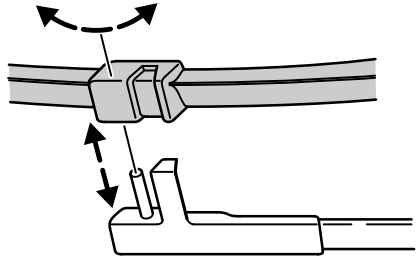

E78156

Lift the wiper arm. Position the wiper blade at a right angle to the wiper arm. Remove the blade from the arm and replace it.

Rear window wiper blades

Lift the wiper arm and position the wiper blade at a right angle to the wiper arm. To remove, press the retaining clip, disengage the wiper blade and pull it off the arm in the opposite direction.

Lighting

LIGHTING CONTROL

Lighting control positions

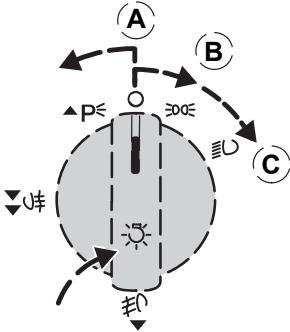

E72161

- A Off
- B Side and tail lamps
- C Headlamps
- D Parking lamps

Parking lamps

Push in and turn anticlockwise.

Autolamps

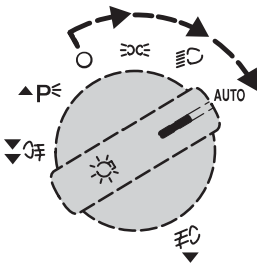

E72162

WARNING

 The autolamps feature is an auxiliary system which is not intended to relieve the driver of his responsibility for the vehicle's exterior lighting.

When the switch is set to **AUTO**, the dipped beam headlamps will switch on and off automatically depending on the ambient light. The autolamps are activated only when the ignition switch is on (position II).

Note: Main beam can be activated only when the autolamps feature has turned on the headlamps.

In **AUTO** mode, if main beam is selected and the autolamps feature switches off the headlamps, the main beam will also be switched off. The next time the headlamps are switched on automatically, they will come on on dipped beam. Main beam must then be reselected by pulling the multi-function lever towards the steering wheel.

Main/dipped beam

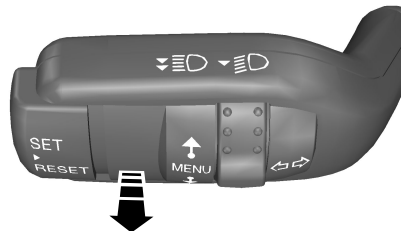

E71095

Lighting

Pull the lever two steps towards the steering wheel to toggle between main and dipped beam.

Headlamp flasher

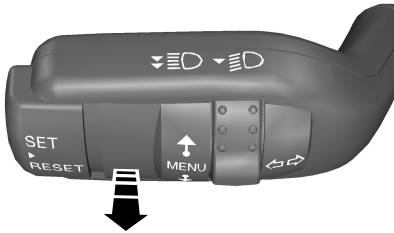

E71095

Pull the lever one step towards the steering wheel.

Home safe feature

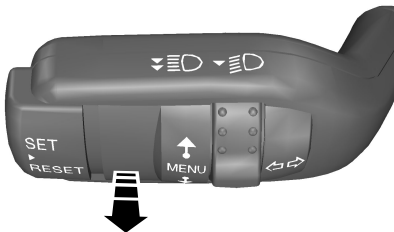

E71095

When the ignition is switched off, the headlamps can be switched on (dipped beam) by pulling the lever towards the steering wheel. The headlamps will switch off automatically 30 seconds after the last door is closed.

FRONT FOG LAMPS

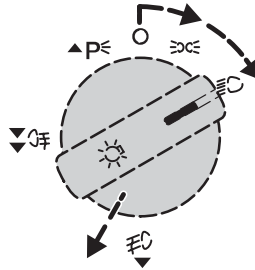

E72163

Note: It is not possible to switch on the front fog lamps when the lighting switch is set to AUTO. To switch on the front fog lamps, switch off the autolamps feature.

Switch on the headlamps **1** and pull out the control switch one position **2**.

The front fog lamps should be used only when visibility is considerably restricted by fog, snow or rain.

Lighting

REAR FOG LAMPS

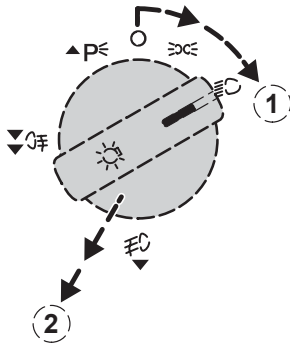

E72164

WARNING

 The rear fog lamps may only be used when visibility is restricted to less than 50 m and must not be used when it is raining or snowing.

Note: On vehicles not equipped with front fog lamps the control switch can be pulled out only one position.

Note: It is not possible to switch on the rear fog lamps when the lighting switch is set to AUTO. To switch on the rear fog lamps, switch off the autolamps feature.

Switch on the exterior lamps **1** and pull out the control two positions **2**.

ADJUSTING THE HEADLAMPS

Xenon headlights

Xenon headlamps can be adjusted for driving on the left or right hand side of the road by an expert.

Halogen headlamps

Special foils can be used to adjust halogen headlamps for driving on the left or right hand side of the road.

AFS headlamps

To adjust the headlamps for driving on the left or right hand side of the road:

Remove the headlamp assembly from the vehicle and remove the cover. See **Changing a bulb** (page 74).

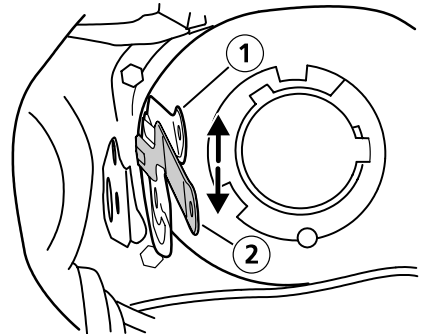

E78861

Lighting

The headlamps are adjusted using a lever in the headlamp unit. Position **1** is the normal setting. For driving on the other side of the road, push the lever down to position **2**.

When returning from abroad, set the lever back to position **1**.

HEADLAMP LEVELLING



E78810

- A Without headlamp levelling
- B With headlamp levelling

The level of the headlamp beams can be adjusted according to the vehicle load.

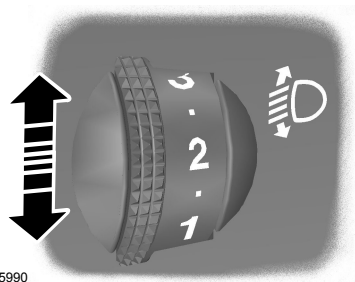

E65990

Lighting

Recommended headlamp levelling control positions

Load			Control position
Persons		Load in luggage compartment ¹	
Front seats	Rear seats		
1	-	-	0
2	-	-	0
2	3	-	1
2	3	Max	2
1	-	Max	3

¹ See **Technical specifications** (page 246). Higher control positions (+1) may be necessary when towing a trailer.

HAZARD WARNING FLASHERS

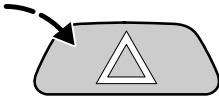

Press the switch to turn on or off. The hazard warning flasher switch does not flash. The hazard warning flashers can also be operated when the ignition is off.

E78855

Lighting

ADAPTIVE FRONT LIGHTING SYSTEM (AFS)

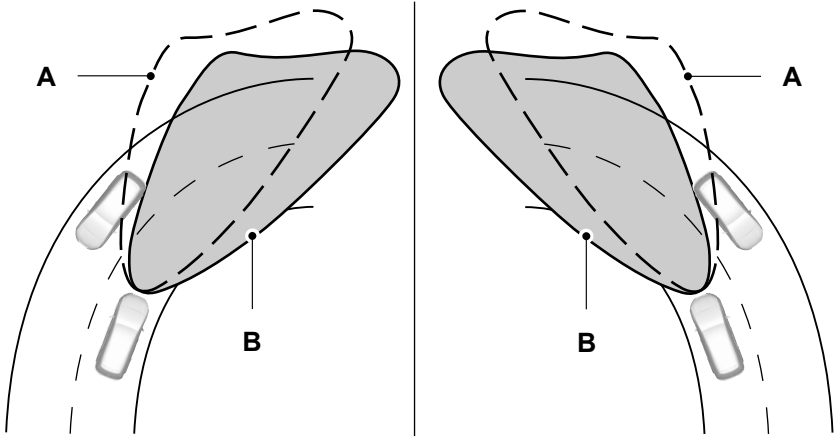

E72897

- A without AFS
- B with AFS

When dipped beam is switched on, the Adaptive Front Lighting System adjusts the headlamp beam automatically depending on the vehicle direction and road speed.

It provides the following benefits:

- It improves visibility when driving at night.
- It helps to reduce headlamp glare for oncoming drivers.

Note: The headlamps will also move when the vehicle is stationary and the steering wheel is turned. To prevent headlamp glare for the oncoming traffic, they will only move towards the passenger side of the vehicle.

Note: When reverse gear is selected, the AFS is deactivated. It is also deactivated when the Daytime Running lights are activated.

To activate the AFS when the Daytime Running Lights are activated, turn the lighting control to position C. See **Lighting control** (page 65).

Lighting

If there is a malfunction of the system, **ADAPTIVE FRONT LIGHT FAILURE** appears in the information display and the headlamp indicator flashes.

The headlamps will move to the central position and/or dipped position and remain in this position. Have the system checked by an expert.

DIRECTION INDICATORS

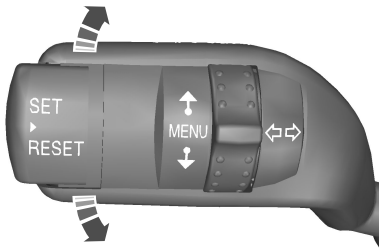

E71098

If the lever is tapped up or down, the direction indicators will flash three times.

INTERIOR LAMPS

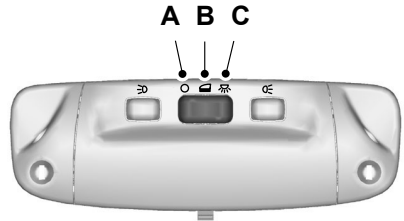

E71945

- A Off
- B Door contact
- C On

The interior lamps illuminate when a door is unlocked or opened.

Depending on the equipment fitted, the following lamps extinguish after the ignition is switched off:

- Interior lamps after a short time or after ten minutes if they are illuminated continuously.
- Reading and vanity mirror lamps after approximately 30 minutes.

To turn the interior lamps back on, switch the ignition to position **II** for a short time, or close and re-open a door.

Lighting

Reading lamps

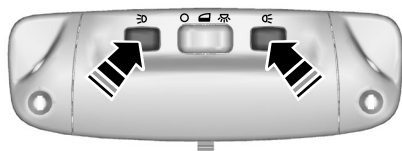

E71946

Vanity mirror lamps

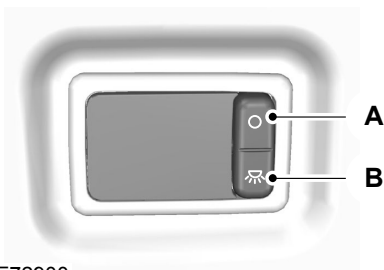

E72900

- A Off
- B On

Centre console illumination

The centre console is illuminated when the side lamps or headlamps are switched on.

You can use the instrument lighting dimmer to adjust the brightness of the illumination together with the instrument panel lighting. See **Instrument lighting dimmer** (page 146).

REMOVING A HEADLAMP

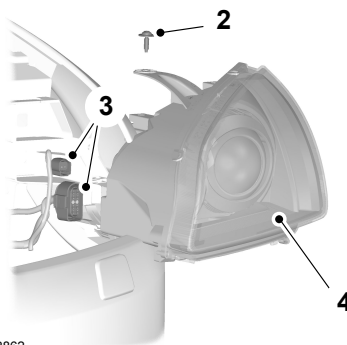

E78862

1. Open the bonnet. See **Opening and closing the bonnet** (page 210).
2. Remove the screw.
3. Disconnect the electrical connectors.
4. Remove the headlamp.

Lighting

REMOVING A REAR LAMP

3-door and 5-door

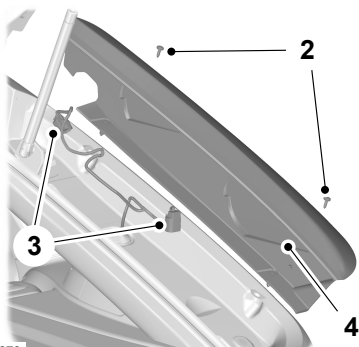

E78870

1. Open the luggage compartment lid.
2. Remove the screws.
3. Disconnect the electrical connectors.
4. Remove the rear lamp.

Estate

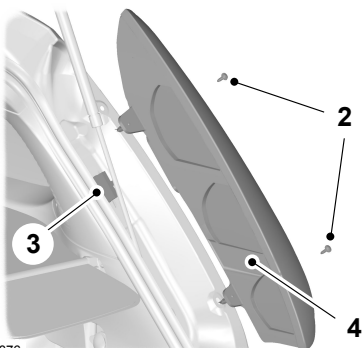

E78876

1. Open the luggage compartment lid.
2. Remove the screws.
3. Disconnect the electrical connector.
4. Remove the rear lamp.

Convertible

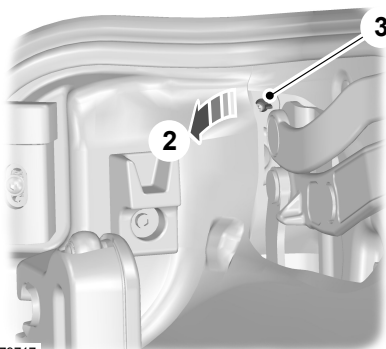

E79717

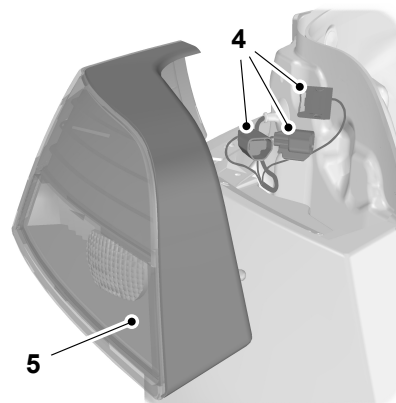

E79718

Lighting

1. Open the luggage compartment lid.
2. Pull back the carpet.
3. Remove the nut.
4. Disconnect the electrical connectors.
5. Remove the rear lamp.

Note: You will need to remove the rear lamp to change the brake lamp, tail lamp or rear direction indicator bulbs. See **Removing a rear lamp** (page 73).

Note: The following instructions describe how to remove the bulbs. Fit replacements in the reverse order unless otherwise stated.

CHANGING A BULB

WARNINGS

- ⚠ Switch the lights and the ignition off.
- ⚠ Let the bulb cool down before removing it.
- ⚠ We recommend that you ask your dealer to change the bulbs if your vehicle is fitted with Xenon headlamps. There is a risk of injury due to high voltage.

CAUTIONS

- ⚠ Do not touch the glass of the bulb.
- ⚠ Only fit bulbs of the correct specification. See **Bulb specification chart** (page 85).

Note: You will need to remove the headlamp to change the headlamp, side lamp or front direction indicator bulbs. See **Removing a headlamp** (page 72).

Note: You will need to remove the headlamp cover to change the main beam, dipped beam and side lamp bulbs.

Removing a headlamp cover

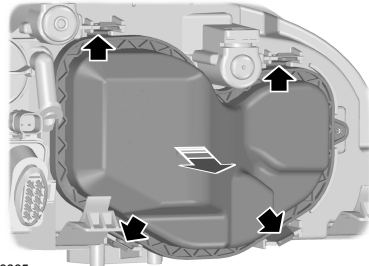

E78865

Headlamp dipped beam

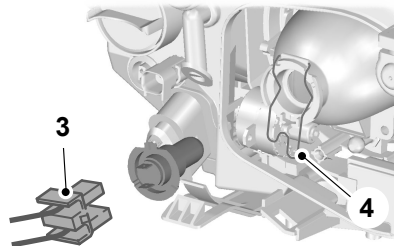

E78866

1. Remove the headlamp. See **Removing a headlamp** (page 72).
2. Remove the cover.

Lighting

3. Disconnect the electrical connector.
4. Release the clip and remove the bulb.

Headlamp main beam

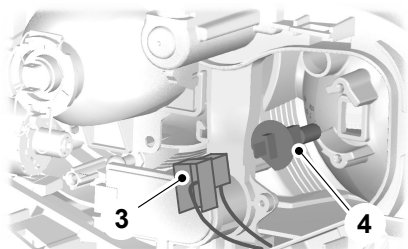

E78867

1. Remove the headlamp. See **Removing a headlamp** (page 72).
2. Remove the cover.
3. Disconnect the electrical connector.
4. Remove the bulb.

Side lamps

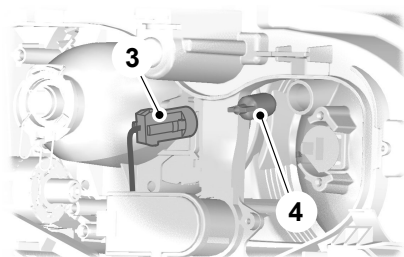

E78868

1. Remove the headlamp. See **Removing a headlamp** (page 72).
2. Remove the cover.
3. Remove the bulb and the bulb holder.
4. Remove the bulb.

Front direction indicators

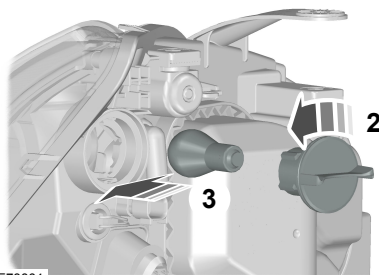

E78864

1. Remove the headlamp. See **Removing a headlamp** (page 72).
2. Turn the bulb holder anti-clockwise and remove it.
3. Gently press the bulb into the bulb holder, turn it anti-clockwise and remove it.

Front fog lamps

Note: You cannot separate the bulb from the bulb holder.

Lighting

All vehicles except ST and convertible

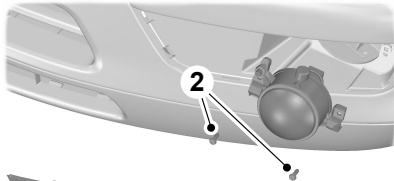

E79592

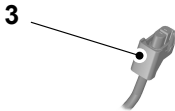
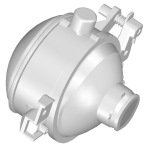

E79593

1. Remove the cover.
2. Remove the screws.
3. Disconnect the electrical connector.
4. Turn the bulb holder anti-clockwise and remove it.

ST and convertible only

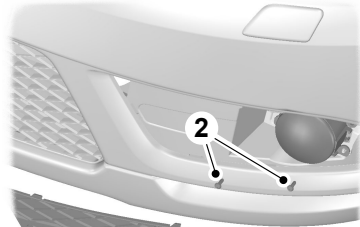

E79594

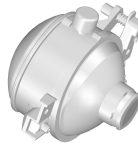

E79593

1. Remove the screw and remove the cover.
2. Remove the screws.
3. Disconnect the electrical connector.
4. Turn the bulb holder anti-clockwise and remove it.

Lighting

Side repeaters

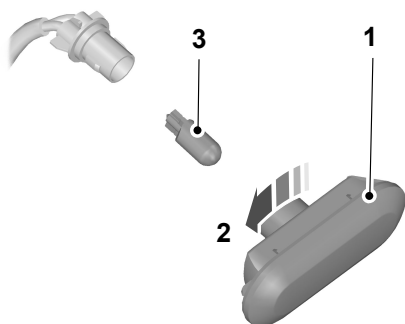

E78869

1. Carefully remove the side repeater.
2. Hold the bulb holder, turn the housing anti-clockwise and remove it.
3. Remove the bulb.

Side repeaters on exterior mirrors

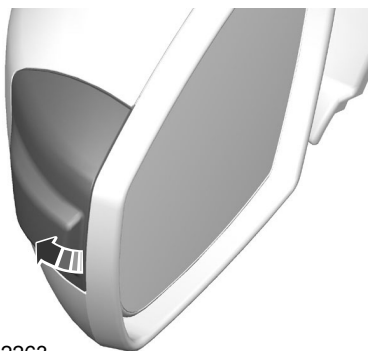

E72263

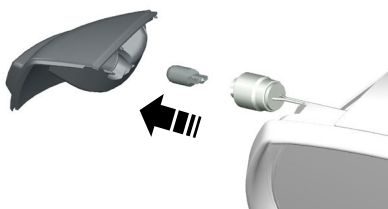

E72291

1. Carefully remove the lamp by pressing it towards the front of the vehicle.
2. Remove the bulb and the bulb holder.
3. Remove the bulb.

Approach lamps

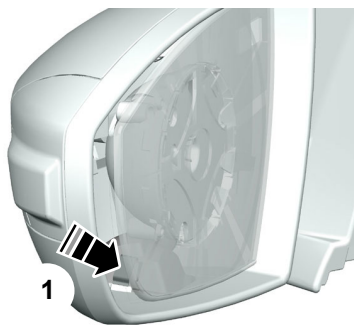

E72264

Lighting

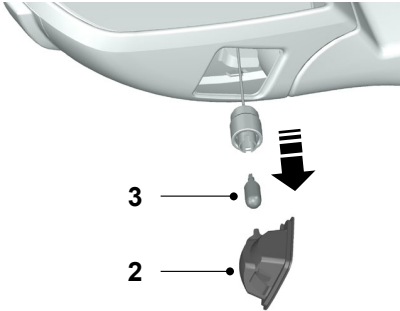

E72265

1. Turn the mirror glass as far inwards as possible and release the retaining clip.
2. Remove the lamp.
3. Remove the bulb.

Rear lamps - except convertible

3-door and 5-door

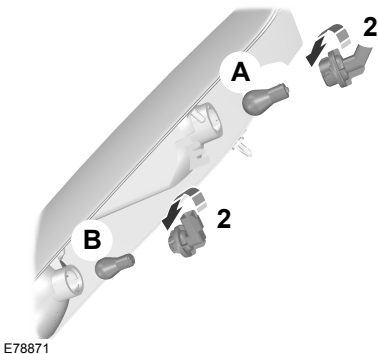

E78871

- A Direction indicator lamp
B Brake and tail lamp

1. Remove the rear lamp. See **Removing a rear lamp** (page 73).
2. Turn the bulb holder anti-clockwise and remove it.
3. Remove the bulb.

Rear fog lamp, reversing lamp

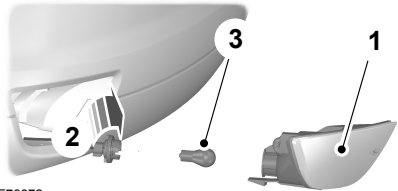

E78872

1. Carefully remove the lamp.
2. Turn the bulb holder anti-clockwise and remove it.
3. Remove the bulb.

4-door

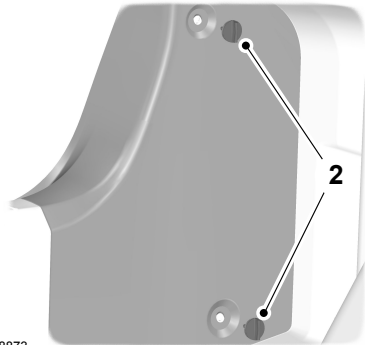

E78873

Lighting

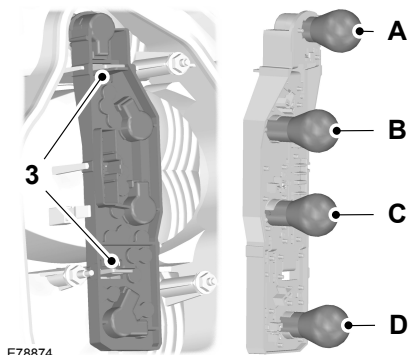

- A Brake lamp
- B Reversing lamp
- C Direction indicator lamp
- D Fog and tail lamp

1. Open the luggage compartment lid.
2. Remove the trim panel retaining clips and remove the trim panel.

3. Unclip the bulb holder.
4. Gently press the bulb into the bulb holder, turn it anti-clockwise and remove it.

Estate

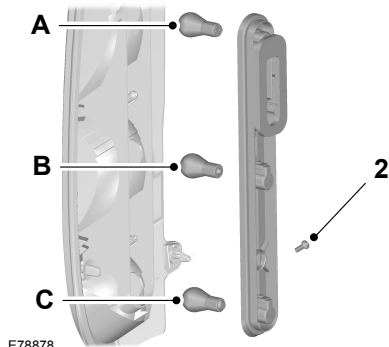

- A Brake and tail lamp
- B Direction indicator lamp
- C Reversing and fog lamp

1. Remove the rear lamp. See **Removing a rear lamp** (page 73).
2. Remove the screw and remove the bulb holder.
3. Gently press the bulb into the bulb holder, turn it anti-clockwise and remove it.

Lighting

Rear lamps - convertible

Brake lamps

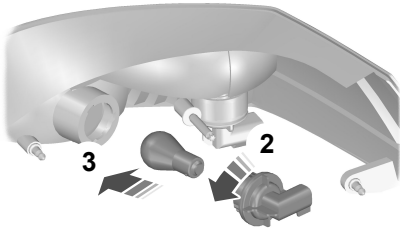

E79600

1. Remove the rear lamp. See **Removing a rear lamp** (page 73).
2. Turn the bulb holder anti-clockwise and remove it.
3. Remove the bulb.

Rear direction indicators

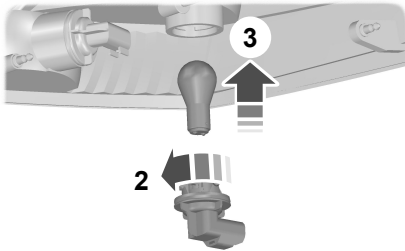

E79599

1. Remove the rear lamp. See **Removing a rear lamp** (page 73).
2. Turn the bulb holder anti-clockwise and remove it.
3. Remove the bulb.

Tail lamps

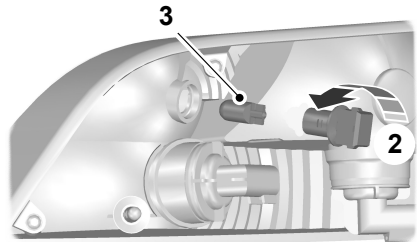

E79597

1. Remove the rear lamp. See **Removing a rear lamp** (page 73).
2. Turn the bulb holder anti-clockwise and remove it.
3. Remove the bulb.

Rear fog lamps

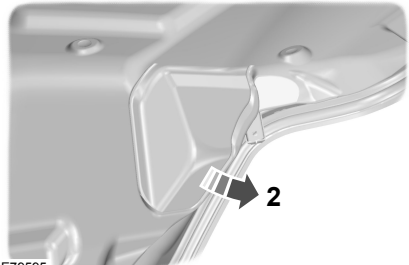

E79595

Lighting

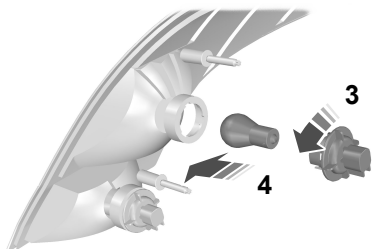

E79596

1. Open the luggage compartment lid.
2. Open the trim panel.
3. Turn the bulb holder anti-clockwise and remove it.
4. Remove the bulb.

Reversing lamps

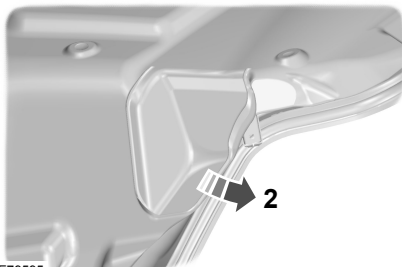

E79595

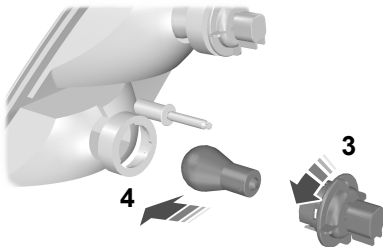

E79598

1. Open the luggage compartment lid.
2. Open the trim panel.
3. Turn the bulb holder anti-clockwise and remove it.
4. Remove the bulb.

Central brake lamp

3-door, 5-door and Estate

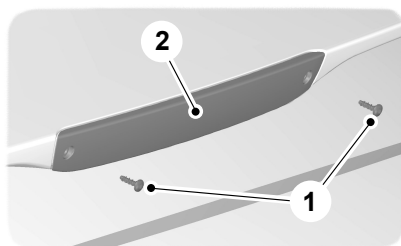

E78879

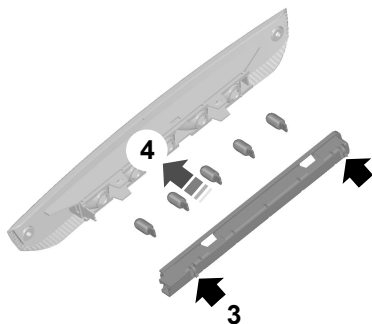

E79601

1. Remove the screws.
2. Remove the lamp.
3. Unclip the bulb holder.
4. Remove the bulb.

Lighting

4-door

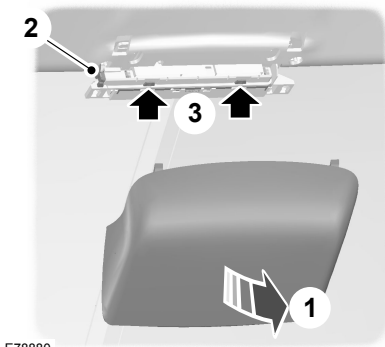

E78880

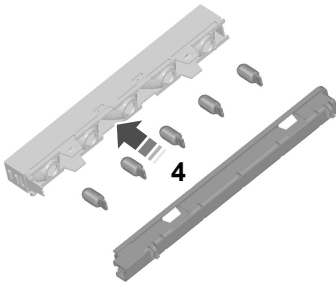

E78881

1. Remove the cover.
2. Disconnect the electrical connector.
3. Unclip the bulb holder.
4. Remove the bulb.

Convertible

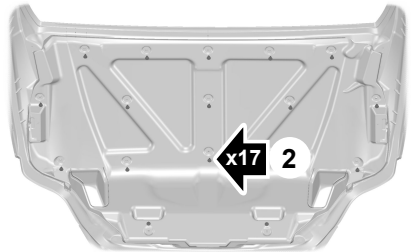

E79602

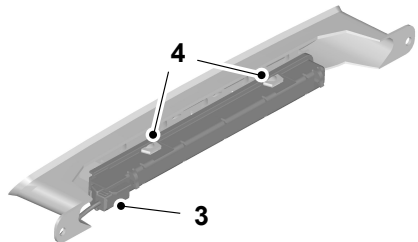

E79603

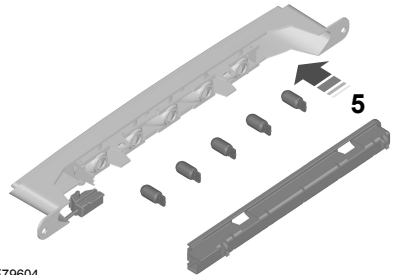

E79604

1. Open the luggage compartment lid.
2. Remove the luggage compartment lid trim.
3. Disconnect the electrical connector.

Lighting

4. Unclip the bulb holder.
5. Remove the bulb.

Luggage compartment lamp

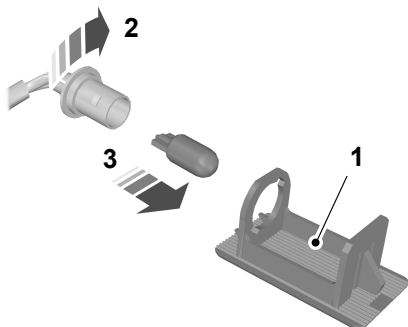

E79605

1. Carefully prise out the lamp.
2. Turn the bulb holder anti-clockwise and remove it.
3. Remove the bulb.

Number plate lamp

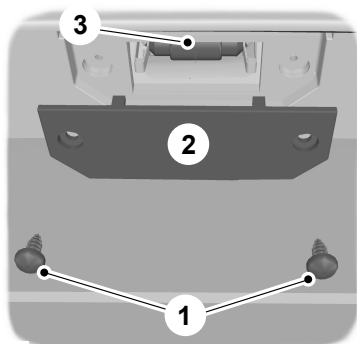

E79606

1. Remove the screws.
2. Remove the lens.
3. Remove the bulb.

Front interior lamp

Vehicles with a perimeter alarm

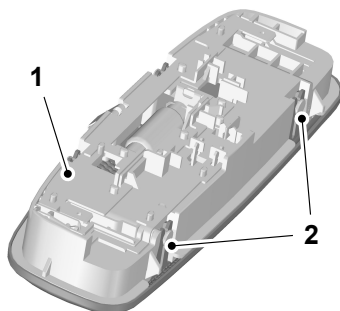

E78128

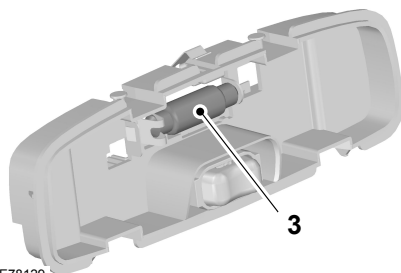

E78129

1. Carefully prise out the lamp.
2. Remove the lens.
3. Remove the bulb.

Lighting

Vehicles with a category one alarm

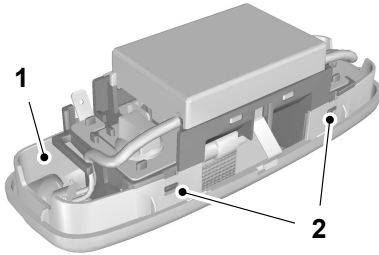

E73091

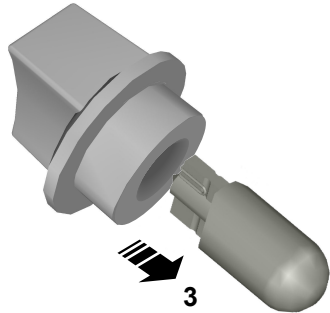

E73939

1. Carefully prise out the lamp.
2. Turn the bulb holder anti-clockwise and remove it.
3. Remove the bulb.

Vanity mirror lamps

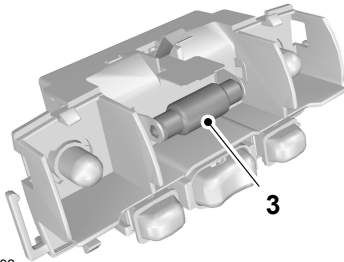

E73092

1. Carefully prise out the lamp.
2. Remove the lens.
3. Remove the bulb.

Front reading lamps

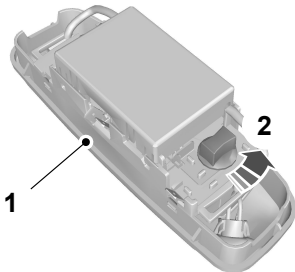

E73938

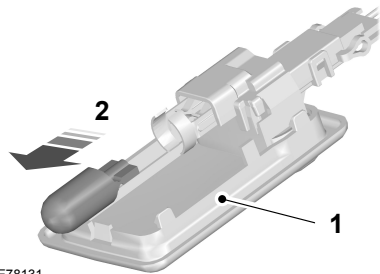

E78131

1. Carefully prise out the lamp.
2. Remove the bulb.

Footwell lamp

5 watt wedge base bulb
Pull the bulb out and replace it.

Lighting

BULB SPECIFICATION CHART

Bulb	Specification (Watts)
Headlamp dipped beam	55 (H7)
Headlamp main beam	55 (H1)
Side lamp	5
Front direction indicator	21
Front fog lamp	35 (H8)
Side repeater	5
Side repeater on exterior mirror	5
Approach lamp	5
Tail and fog lamp (4-door)	5/21
Tail and brake lamp (3-door, 5-door and Estate)	5/21
Tail lamp (convertible)	5/21
Brake lamp	21
Rear direction indicator	21
Reversing lamp	21
Rear fog lamp	21
Central brake lamp	5
Number plate lamp	5
Interior lamp	10
Reading lamp	5
Vanity mirror	5
Luggage compartment lamp	5

Windows and mirrors

ELECTRIC WINDOWS

WARNING

 Before operating the electric windows you should verify they are free of obstructions and ensure that children and/or pets are not in the proximity of window openings. Failure to do so could result in serious personal injury. It is the primary responsibility of the supervising adults to never leave a child unattended in a vehicle and to never leave the keys in an unattended vehicle.

Note: When the switches are operated often during a short period of time, the system might become inoperable for a certain time to prevent damage due to overheating.

Note: The electric windows can also be operated with the ignition off via the global opening and global closing function. See **Global opening and closing** (page 51).

Switch on the ignition to operate the electric windows.

All the windows can be operated by switches located on the door trim panel of the driver's door.

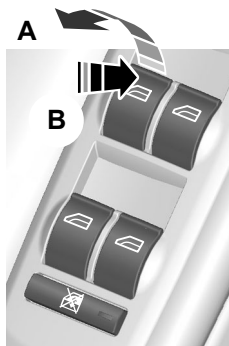

E70848

- A Lift up the front of the switch
- B Press down the front of the switch

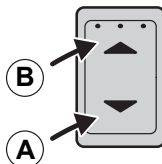

E72185

- A Close
- B Open

Opening and closing a window automatically

Press or lift the switch to the second action point and release it. Press or lift it again to stop the windows.

Windows and mirrors

Isolating the rear window switches



E70850

A switch in the driver's door disables the rear electric window switches.

The indicator in the switch illuminates when the rear electric windows are disabled.

The rear windows can always be operated from the driver's door.

Window anti-trap protection

WARNINGS

 Anti-trap protection is not active while the electric window memory is being reset. Make sure that there are no obstacles in the way of the closing window.

 Careless closing of the electric windows can override the anti-trap protection and cause injuries.

The electric windows will stop automatically while closing and reverse some distance if there is an obstacle in the way.

To override anti-trap protection when there is a resistance, e. g. in the winter, proceed as follows:

Close the window twice until it reaches the resistance and let it reverse.

WARNING

 While the window is being closed for the third time, the anti-trap function is disabled. Make sure there are no obstacles in the way of the closing window.

Close the window a third time to the resistance. The anti-trap function is disabled and the window cannot be closed automatically. The window will override the resistance and can then be closed fully.

If the window does not close after the third attempt, have it checked by an expert.

Windows and mirrors

Resetting the electric window memory

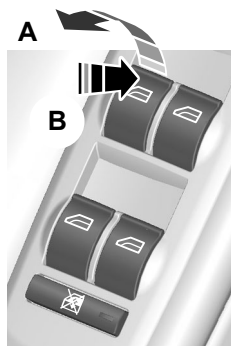

E70848

WARNING

 The anti-trap function is deactivated until the memory has been reset. Careless closing of the window can cause injuries.

Note: The windows cannot be closed automatically until the memory is reset.

After the battery has been disconnected from the vehicle it is necessary to reset the memory separately for each window:

Lift the switch until the window is fully closed. Hold the switch lifted for one more second.

Release the switch and lift it again, two or three times, for one more second.

Open the window and try to close it automatically.

Reset and repeat procedure if the window does not close automatically.

EXTERIOR MIRRORS

Convex outside mirrors

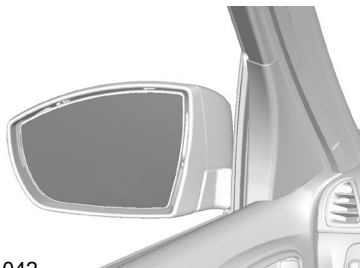

E71042

WARNING

 Do not overestimate the distance of the objects that you see in the convex mirrors. Objects seen in convex mirrors will appear smaller and further away than they actually are.

The mirrors increase your rearward field of vision to reduce the so-called blind spot at the rear quarter of your vehicle.

Windows and mirrors

Folding outside mirrors

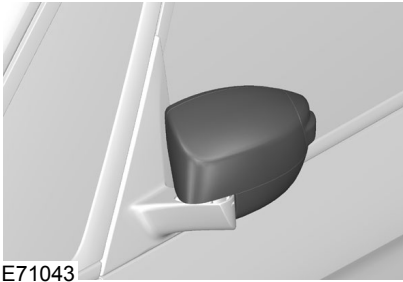

Make sure that you fully engage the mirror in its support when returning it to its original position.

ELECTRIC EXTERIOR MIRRORS

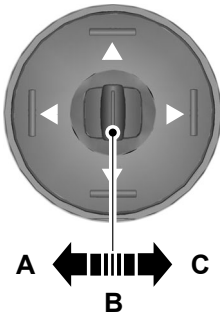

E70846

- A Left-hand mirror
- B Off
- C Right-hand mirror

The switch is located in the trim panel of the driver's door.

Mirror tilting positions

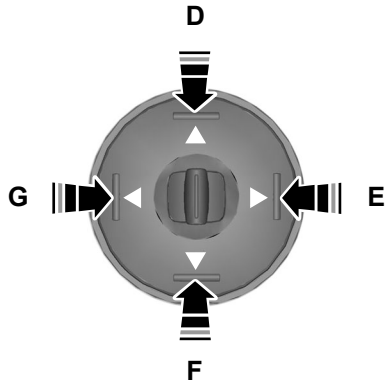

E70847

- D up
- E right
- F down
- G left

On some models, the door mirrors are heated when the heated rear window is switched on.

Electric folding mirrors

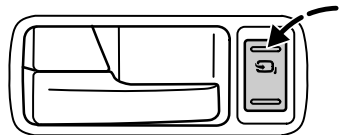

E78811

Note: When the mirrors are operated often during a short period of time, the system might become inoperable for a certain time to prevent damage due to overheating.

Windows and mirrors

Operates with the ignition on or off.

To fold/unfold the mirrors, briefly press the switch. If the switch is pressed again while the mirrors are moving, they will stop and reverse the direction of movement.

INTERIOR MIRROR

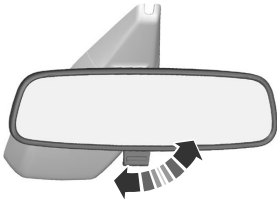

E71027

Dip the mirror to reduce glare when driving at night.

Auto-dimming mirror

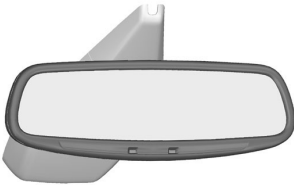

E71028

The auto-dimming mirror automatically activates the dimming function when hit by glaring light from behind. The function is automatically deactivated when you select reverse gear.

Instruments

INSTRUMENT PANEL OVERVIEW - LHD

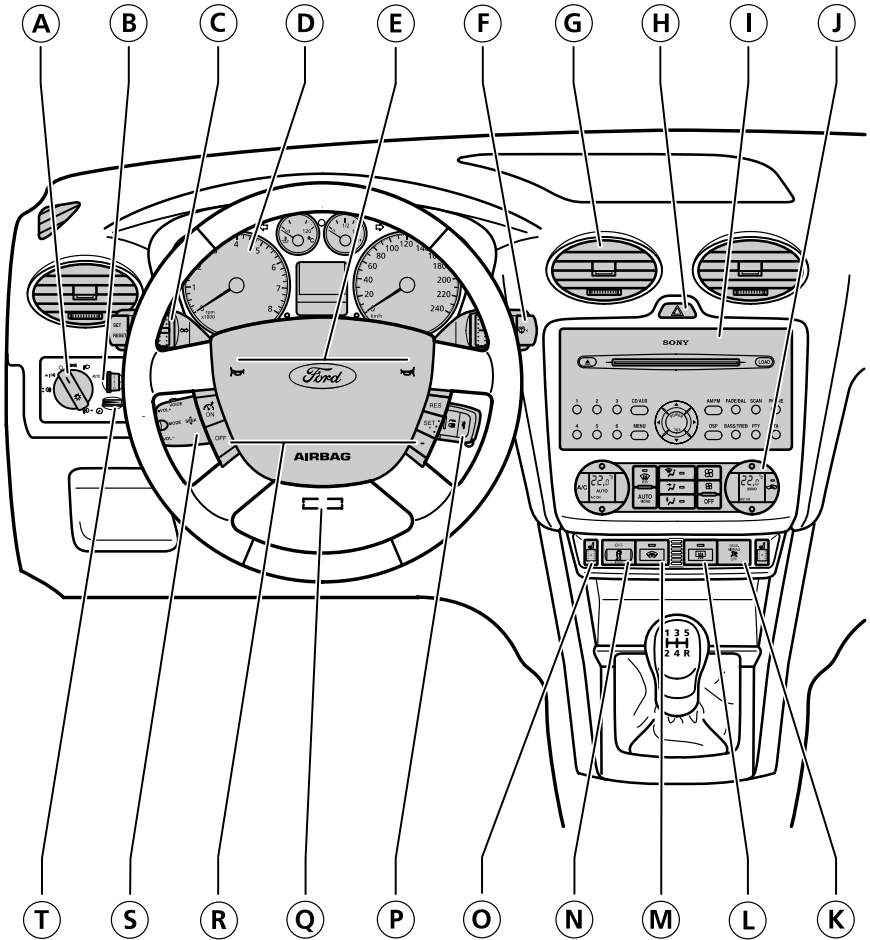

E78773

Instruments

- A Lighting control. See **Lighting control** (page 65). Front fog lamps. See **Front fog lamps** (page 66). Rear fog lamp. See **Rear fog lamps** (page 67).
- B Headlamp levelling control. See **Headlamp levelling** (page 68).
- C Multi-function lever: Information display controls. See **Information displays** (page 104). Direction indicators. See **Direction indicators** (page 71). Main beam. See **Lighting control** (page 65).
- D Instrument cluster. See **Gauges** (page 95). See **Warning lamps and indicators** (page 98).
- E Horn. See **Horn** (page 57).
- F Wiper lever. See **Wipers and washers** (page 60).
- G Air vents. See **Air vents** (page 125).
- H Hazard warning flasher switch. See **Hazard warning flashers** (page 69).
- I Audio/navigation unit. See separate handbook.
- J Climate controls. See **Climate control** (page 125).
- K Airbag deactivation indicator. See **Disabling the passenger airbag** (page 33).
- L Heated rear window switch. See **Heated windows and mirrors** (page 132).
- M Heated windscreen switch. See **Heated windows and mirrors** (page 132).
- N Stability control (ESP) switch. See **Using stability control** (page 175).
- O Heated front seat switch. See **Heated seats** (page 145).
- P Ignition switch. See **Ignition switch** (page 151).
- Q Steering wheel adjustment. See **Adjusting the steering wheel** (page 57).
- R Cruise control switches. See **Using cruise control** (page 178).
- S Audio controls. See **Audio control** (page 57).
- T Instrument lighting dimmer. See **Instrument lighting dimmer** (page 146).

Instruments

INSTRUMENT PANEL OVERVIEW - RHD

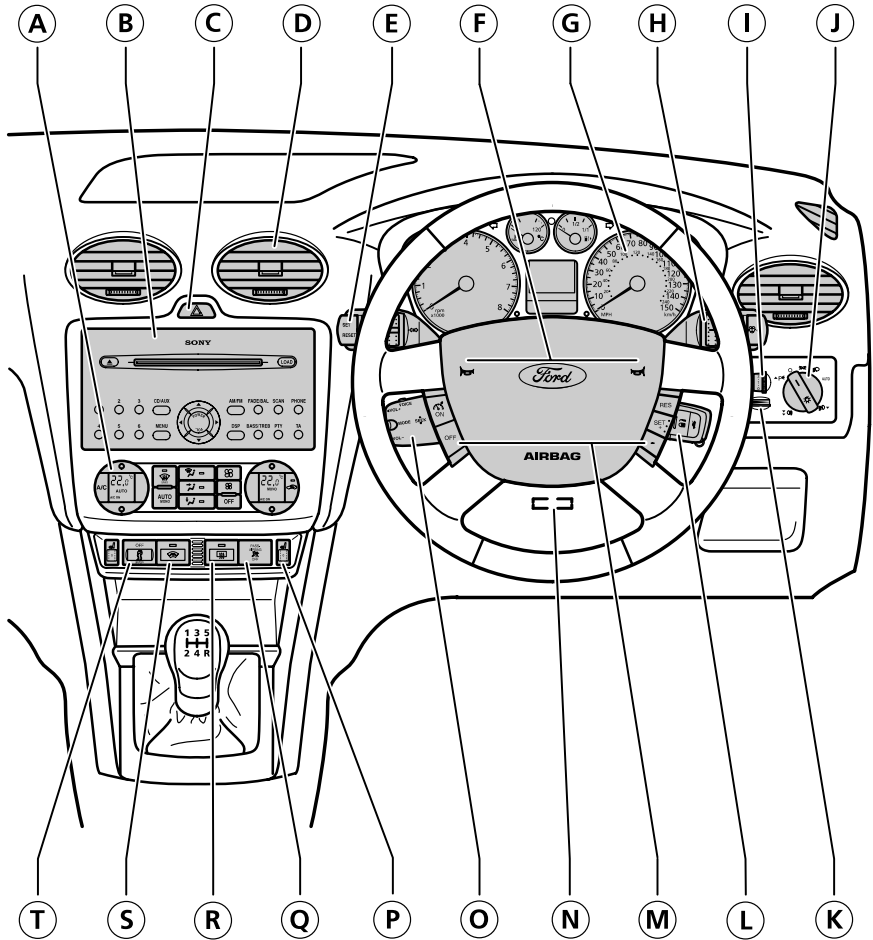

E78774

- A Climate controls. See **Climate control** (page 125).
- B Audio/navigation unit. See separate handbook.

Instruments

- C Hazard warning flasher switch. See **Hazard warning flashers** (page 69).
- D Air vents. See **Air vents** (page 125).
- E Multi-function lever: Information display controls. See **Information displays** (page 104). Direction indicators. See **Direction indicators** (page 71). Main beam. See **Lighting control** (page 65).
- F Horn. See **Horn** (page 57).
- G Instrument cluster. See **Gauges** (page 95). See **Warning lamps and indicators** (page 98).
- H Wiper lever. See **Wipers and washers** (page 60).
- I Headlamp levelling control. See **Headlamp levelling** (page 68).
- J Lighting control. See **Lighting control** (page 65). Front fog lamps. See **Front fog lamps** (page 66). Rear fog lamp. See **Rear fog lamps** (page 67).
- K Instrument lighting dimmer. See **Instrument lighting dimmer** (page 146).
- L Ignition switch. See **Ignition switch** (page 151).
- M Cruise control switches. See **Using cruise control** (page 178).
- N Steering wheel adjustment. See **Adjusting the steering wheel** (page 57).
- O Audio controls. See **Audio control** (page 57).
- P Heated front seat switch. See **Heated seats** (page 145).
- Q Airbag deactivation indicator. See **Disabling the passenger airbag** (page 33).
- R Heated rear window switch. See **Heated windows and mirrors** (page 132).
- S Heated windscreen switch. See **Heated windows and mirrors** (page 132).
- T Stability control (ESP) switch. See **Using stability control** (page 175).

Instruments

GAUGES

All vehicles

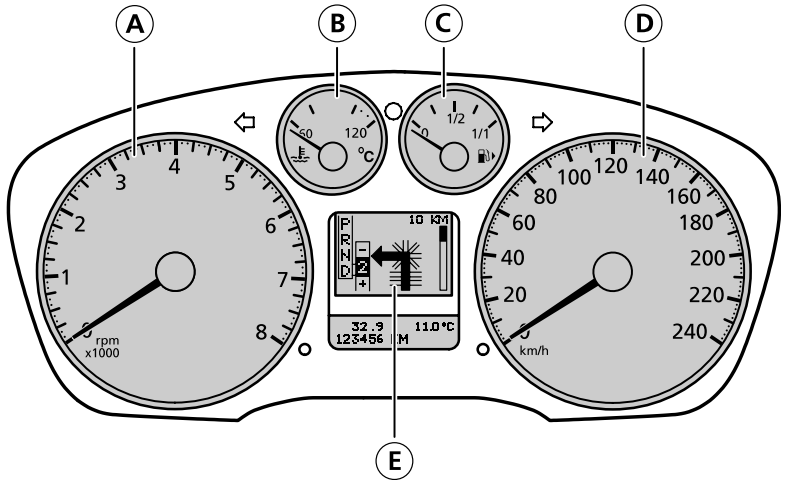

E78038

- A Tachometer
- B Engine coolant temperature gauge
- C Fuel gauge
- D Speedometer
- E Information display/Tripmeter reset button

Instruments

FocusST

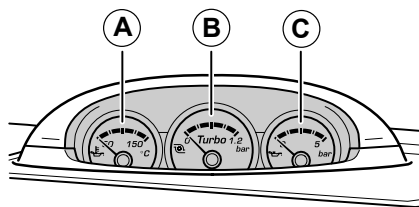

E78808

A	Oil temperature gauge
B	Turbocharger boost gauge
C	Oil pressure gauge

Engine coolant temperature gauge

All vehicles

At normal operating temperature, the needle remains within the centre section.

If the needle enters the red section, the engine is overheating. Switch off the ignition and determine the source of the problem once the engine has cooled down.

Vehicles with an information display

In addition, the message **HIGH ENGINE TEMPERATURE** will appear in the display.

Oil temperature gauge

Indicates the temperature of the the engine oil.

At normal operating temperature, the needle remains within the normal area.

If it enters the red section, the engine is overheating. Reduce engine speed as soon as safely possible to allow the engine to cool. If the engine is continued to be driven at high engine speeds with the needle in the red section, the engine speed will be reduced automatically to prevent engine damage.

This gauge indicates the **temperature** of the engine oil, not the oil level.

Turbocharger boost gauge

Indicates the added intake pressure provided by the turbocharger.

Oil pressure gauge

WARNING



Driving with your oil pressure gauge pointer continuously in the red section of the scale may damage the engine.

Note: When the engine is cold, oil pressure close to 5 bar may be indicated. This is normal. As the engine warms up, the oil pressure will drop.

This gauge indicates engine oil pressure up to a recommended safe maximum of 5 bar.

Instruments

During normal driving the indicated oil pressure will vary with engine speed, the pressure rising as engine speed rises and dropping as engine speed drops.

If the engine oil pressure drops below the normal range, the oil pressure gauge pointer will drop into the red section of the gauge scale and the engine oil pressure warning lamp in the main instrument cluster will illuminate. Stop the vehicle as soon as safely possible and switch off the engine immediately. Check the oil level and add oil if needed. See **Engine oil check** (page 218).

Tachometer

On vehicles with a diesel engine, the tachometer goes to 6 000 revolutions per minute.

Fuel gauge

The arrow adjacent to the fuel pump symbol indicates on which side of the vehicle the fuel filler cap is located.

Information display

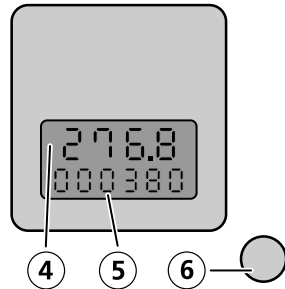
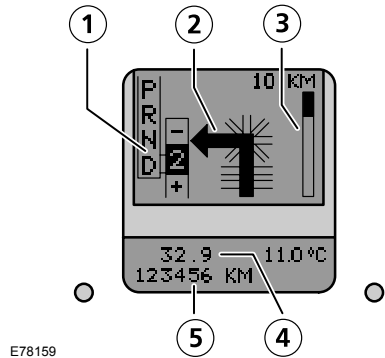

Vehicles with an automatic transmission

On vehicles with an automatic transmission, the following will be shown:

The gear currently selected by the transmission **1** – **P** (Park), **R** (Reverse), **N** (Neutral) or **D** (Drive).

The mode currently selected – automatic or manual.

Instruments

In manual mode, the display shows the gear currently selected by the transmission.

See **Automatic transmission** (page 165).

Vehicles with a navigation system

On vehicles with a navigation system, the following will be shown when the navigation system is operating:

The arrow **2** will show the direction of the next turn.

The status bar on the right **3** of the display will count down the distance to the next turn.

Tripmeter 4

Registers the distance of individual journeys.

Odometer 5

Registers the total distance of the vehicle.

WARNING LAMPS AND INDICATORS

The following warning lamps and indicators illuminate when the ignition is switched on:

- Airbag
- Oil pressure
- Engine immobiliser
- ABS
- Stability control (ESP)
- Engine

- Doors open
- Brake system
- Engine systems fault
- Frost
- Power steering
- Ignition

If a warning lamp or indicator does not illuminate when the ignition is switched on, it indicates a malfunction. Have the system checked by an expert.

ABS warning lamp



If the ABS warning lamp illuminates when driving, it indicates a malfunction.

Have this checked by an expert. Normal braking (without ABS) will be maintained.

Airbag warning lamp



If the warning lamp does not illuminate, if it stays on or illuminates intermittently or continuously while driving, it means there is a malfunction. Have the system checked by an expert.

Brake system warning lamp

WARNING



If it illuminates after releasing the parking brake or when driving, have the braking system checked by an expert immediately.

Instruments



The brake system warning lamp remains illuminated when the parking brake is engaged. It will also illuminate if the brake fluid level falls below the **MIN** mark.

Brake system and ABS warning lamps

WARNING



Reduce vehicle speed gradually. Use the brakes with great care. Do not step on the brake pedal abruptly.

If **both** warning lamps illuminate at the same time when driving, **stop the vehicle** as soon as it is safe to do so. Have the braking system checked by an expert before continuing your journey.

Cruise control indicator



The indicator in the instrument cluster will illuminate when the system is in use.

Direction indicator



A sudden increase in the rate of flashing warns of a failed indicator bulb.

Doors open warning lamp



Illuminates when the ignition is switched on and remains on if any door, the bonnet or the luggage compartment is not closed properly.

Engine systems fault warning lamp



Illuminates to indicate a malfunction of the engine and powertrain related systems. Stop the vehicle as soon as safely possible and switch off the engine immediately. Have the engine checked by an expert immediately.

Engine warning lamp



If it illuminates with the engine running, it indicates a malfunction. If it flashes when driving, reduce the vehicle speed immediately. If it continues to flash, avoid heavy acceleration and high engine speed. Have your vehicle checked by an expert immediately.

Front fog lamp indicator



The indicator will illuminate when the front fog lamps are in use.

Instruments

Frost warning lamp

WARNING

 Even if the temperature rises to above +4°C there is no guarantee that the road is free of hazards caused by inclement weather.

 At temperatures between +4°C and +1°C, the orange frost warning lamp illuminates. At temperatures below +1°C, the warning lamp glows red.

Glow plug indicator

 If the glow plug indicator lamp illuminates, wait until the it extinguishes before starting.

Headlamp indicator

 The headlamp indicator illuminates when the headlamps are on dipped beam or when the side and tail lamps are on.

Ignition warning lamp

Note: If the battery voltage is too high or too low, the ignition warning lamp will illuminate and the heated windscreen and heated rear window, the auxiliary heater or the air conditioning may switch on or off automatically.



If it illuminates whilst driving, switch off all unnecessary electrical equipment and drive immediately to the nearest expert.

Low fuel level warning lamp



The warning lamp illuminates when there is enough fuel in the tank for the vehicle to travel 80 km (50 miles). This is calculated based on average fuel consumption.

Main beam indicator



Illuminates when the headlamps are on main beam or when the headlamp flasher is used.

Maximum engine RPM warning lamp



Illuminates when the maximum engine RPM (revolutions per minute) is reached.

Oil pressure warning lamp

WARNING



Do not resume the journey if the oil level is correct. Have the engine checked by an expert.

Instruments



If it stays on after starting or illuminates during a journey, stop immediately, switch off the engine and check the engine oil level. Top up straight away if the level is low.

Power steering warning lamp



Illuminates to indicate a malfunction of the power steering system. Full steering will be maintained but you will need to exert greater force on the steering wheel. Have the system checked by an expert as soon as possible.

Rear fog lamp indicator



The indicator in the instrument cluster will illuminate when the rear fog lamps are switched on.

Seat belt reminder

WARNINGS



The seat belt reminder remains in stand-by mode after the driver/front passenger has fastened his/her seat belt. It will be reactivated if the driver/front passenger unbuckles his/her seat belt.



Never sit on top of a buckled seat belt to avoid the seat belt reminder. The restraint system can only work properly if passengers have buckled up their seat belts.

Note: Placing objects on the front passenger's seat when it is not occupied may trigger the sensors in the seat and activate the seat belt reminder if the seat belt is not engaged.



When the vehicle's speed exceeds 23 km/h (14 mph), the seat belt reminder will illuminate if the driver's/front passenger's seat belt is unbuckled. The seat belt reminder will not go out until the driver/front passenger has fastened his/her seat belt.

To deactivate the seat belt reminder for one ignition cycle, the driver must buckle and unbuckle the seat belt within 3 seconds with the ignition switched on.

Stability control (ESP) indicator

Note: If the indicator does not illuminate when the ignition is switched on or if it stays illuminated whilst driving, it indicates a malfunction.



Illuminates when stability control is switched off and flashes when stability control (ESP) is activated.

Instruments

AUDIBLE WARNINGS AND INDICATORS

Automatic transmission

If position **P** is not selected, a warning chime will sound when the driver's door is opened.

Electronic parking brake (EPB)

A warning chime will sound if:

- the driver's door is opened before the EPB is applied.
- the EPB is still applied when the vehicle moves off.
- there is a cut in the power supply.

Frost

WARNING



Even if the temperature rises to above +4°C there is no guarantee that the road is free of hazards caused by inclement weather.

A warning chime will sound in the following conditions:

- +4°C or lower: frost warning
- 0°C or lower: danger of icy roads

Key outside car

Vehicles with the key free system

If the engine is running and a passive key is no longer detected within the vehicle interior, a chime will sound as soon as the door is closed.

Key-in-ignition

Except vehicles with the key free system

A warning tone will sound when the driver's door is opened if:

- the key is in the ignition.

Vehicles with the key free system

A warning tone will sound when the driver's door is opened if:

- the ignition switch is not pulled out.
- the spare key is in the ignition.

Lights on

A warning chime will sound if the driver's door is opened with the exterior lights switched on and the ignition switched off.

Low fuel

A warning chime will sound at the following ranges: 80 km (50 miles), 40 km (25 miles), 20 km (12 miles), 0 km (0 miles).

Seat belt reminder

WARNINGS



The seat belt reminder remains in stand-by mode after the driver or front passenger has fastened his or her seat belt. It will be reactivated if the driver or front passenger unbuckles his or her seat belt.

Instruments



Never sit on top of a buckled seat belt to avoid the seat belt reminder function. The restraint system can only work properly if passengers have buckled up their seat belts.

Note: Placing objects on the front passenger's seat when it is not occupied may trigger the sensors in the seat and activate the seat belt reminder if the seat belt is not engaged.

When the vehicle's speed exceeds 23 km/h (14 mph), a chime will sound if the driver's or front passenger's seat belt is unbuckled. The chime will stop after eight minutes.

Stop vehicle - roof operation

A warning chime will sound if the roof opening or closing sequence was enabled during vehicle stand still and driving started.

Information displays

GENERAL INFORMATION

WARNING

 For road safety reasons, set and reset the functions only when the vehicle is stationary.

Various systems can be programmed using the information display and the multi-function lever on the steering column.

The information display also provides warning messages about faults or system malfunctions. See **Information messages** (page 121).

Controls

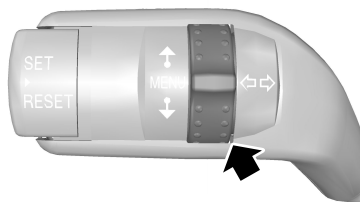

E73265

Turn the rotary control to scroll through the available displays within a menu or to choose a setting. To scroll automatically, hold the rotary control in the upward or downward position.



E73266

Press the **SET/RESET** button to choose a sub-menu and adjust the settings. If the chimes are activated, a short tone will sound each time the button is pressed.

Main menu

Use the rotary control to scroll through the displays and press **SET/RESET** to choose a sub-menu and adjust the settings.

Information displays

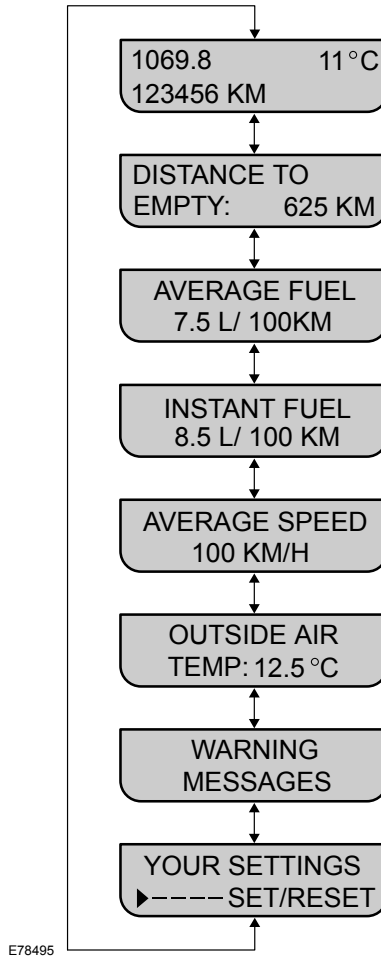

Information displays

Odometer

1069.8 11°C
123456 KM

E81423

Tripmeter

1069.8 11°C
123456 KM

E81424

To reset, press the **SET/RESET** button.

Distance to empty

DISTANCE TO
EMPTY: 625 KM

E78496

Indicates the approximate distance the vehicle will travel on the fuel remaining in the tank. Changes in driving pattern may cause the value to vary.

Average fuel consumption

AVERAGE FUEL
7.5 L/ 100KM

E78497

Indicates the average fuel consumption since the function was last reset.

To reset, scroll to this display using the rotary control and press the **SET/RESET** button.

Instantaneous fuel consumption

INSTANT FUEL
0.7 L/H

E78498

At speeds below 6.5 km/h (4 mph), the display shows the current fuel consumption in litres per hour (gallons per hour).

INSTANT FUEL
8.5 L/ 100 KM

E78499

At speeds above 6.5 km/h (4 mph), it shows the current fuel consumption in litres per 100 km (miles per gallon).

The function cannot be reset.

Average speed

AVERAGE SPEED
100 KM/H

E78500

Indicates the average speed calculated over the last 1 000 km (600 miles) or since last reset.

Press the **SET/RESET** button to set to zero.

Information displays

Outside air temperature

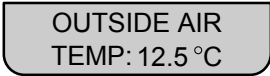

E78501

Shows the outside air temperature.

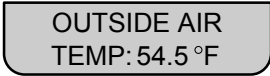

E78502

Note: Toggling between °F and °C in this display will only change the units of measure for temperature in the information display and automatic climate control.

Press and hold the **SET/RESET** button to toggle between metric and imperial systems.

Warning messages

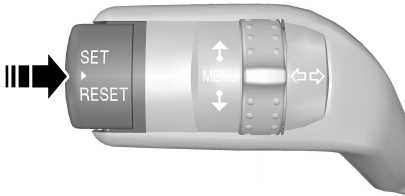

E73266

Each time a warning message appears in the display, the driver must acknowledge it by pressing the **SET/RESET** button. The display then returns to the one previously shown.

Repeat this if further warning messages appear.

Once acknowledged, the warning message(s) will appear in the main menu until the problem has been solved. When scrolling through the main menu, the warning messages will appear one after the other for approximately two seconds each and do not have to be acknowledged with the **SET/RESET** button.

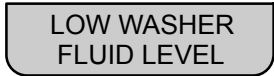

E78503



E78504

Some warning messages are supplemented by a warning lamp next to the display.

Warning messages are supplemented by an amber warning lamp.

Danger messages are supplemented by a red warning lamp.

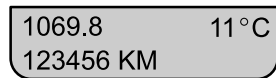

E81425

If a danger or warning message accompanied by one of these lamps is present, the warning lamp will remain illuminated.

Information displays

PERSONALISED SETTINGS

Your settings menu

Note: For road safety reasons, changes in the **Your settings** menu can only be made while the vehicle is stationary. If this menu or one of its sub-menus is open when the vehicle begins to move, the information display will automatically exit the **Your settings** menu.

Use the rotary control to scroll through the displays and press **SET/RESET** to choose a sub-menu and adjust the settings.

Information displays

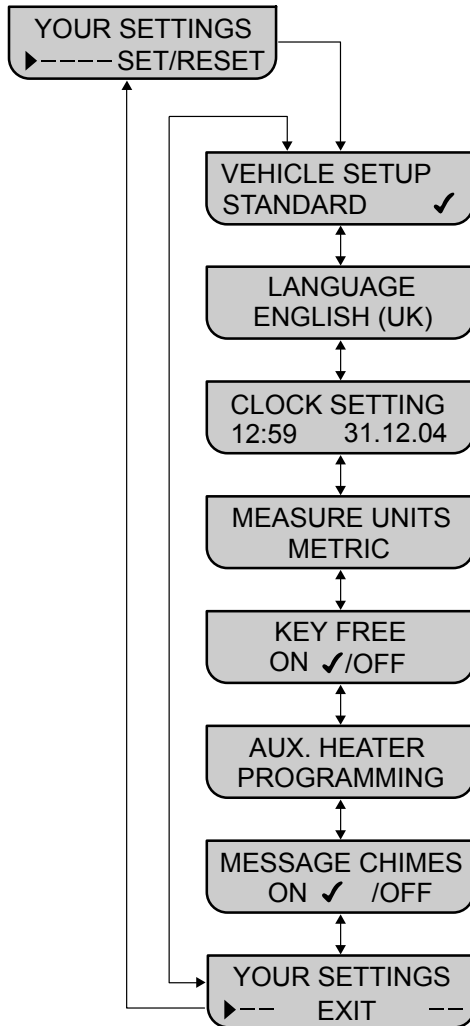

E78505

Information displays

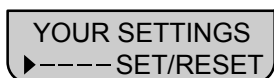

E78506

Scroll to the **Your settings** display using the rotary control and press the **SET/RESET** button.

Vehicle setup menu

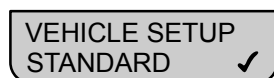

E78507

The steering characteristics on vehicles with electro-hydraulic steering and the shifting behaviour of the Durashift CVT transmission can be adjusted to suit your personal preferences and driving style. The preset settings are **Standard** for the steering and **Adaptive** for the Durashift CVT.

Steering

Note: When the vehicle is stationary, the steering assistance is optimized in all three settings and does not differ noticeably.

Standard: The standard setting suitable for all driving styles.

Sport: The steering assistance is reduced. This suits a sportier driving style by increasing the feedback through the steering wheel. The sport setting is also an advantage when driving on icy and snowy road conditions.

Comfort: The steering assistance is increased. The steering will feel lighter and you will not need to exert as much force on the wheel.

Automatic transmission (Durashift CVT)

Note: Kickdown functions in the same way in all three modes.

Adaptive: The standard setup suitable for all driving styles.

Sport: Initially, the transmission lets the engine run at higher engine speeds to provide faster acceleration and greater engine braking efficiency. Thereafter, it will adapt to your individual driving style.

Economy: The transmission keeps the engine at lower engine speeds in order to optimize fuel economy.

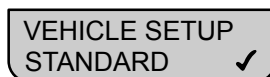

E78507

Note: The **Vehicle setup** display shows the setting currently selected.

To enter the **Vehicle setup** menu, scroll to the **Vehicle setup** display and press **SET/RESET**.

Use the rotary control to scroll through the settings options within the menu and press **SET/RESET** to select the desired setting. A tick appears in the display of the setting which is selected.

The following vehicle setups or options are available:

Information displays

Vehicle setup - Standard

Steering = Standard

Automatic transmission = Adaptive

Vehicle setup - Sport

Steering = Sport

Automatic transmission = Sport

Vehicle setup - Comfort

Steering = Comfort

Automatic transmission = Adaptive

Advanced

See **Advanced menu**.

Vehicle setup - Exit

To exit the **Vehicle setup** menu and return to the **Your settings** menu, scroll to this display and press the **SET/RESET** button.

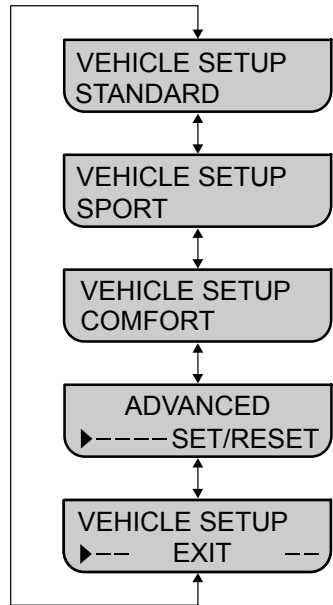

E78508

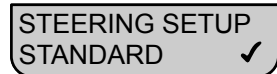

E78509

Note: If your vehicle is not equipped with a Durashift CVT transmission, these **Vehicle setup** menu displays will not appear. You will enter the **Steering setup** menu directly. See **Steering setup menu**.

Saving the settings

Note: When the ignition is switched off and back on, the settings will return to the preset settings.

Information displays

Note: If only one passive key is inside the vehicle, the settings will be saved to this passive key. If more than one passive key is inside the vehicle, the settings will be saved to the passive key that was in the driver's door detection range when the driver's door was opened.

The individual settings can be permanently saved to an ignition key or to a passive key. They are selected automatically when the key is inserted into the ignition switch or the passive key is used to operate the vehicle.

Up to four keys or passive keys can be programmed with individual settings.



E78510

If the settings are changed in any of the **Vehicle setup** menus, **SAVE SETTINGS TO KEY?** will appear in the display before you exit the menu.

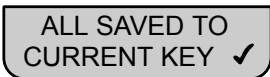

E78511

If you wish to save the current settings to the key in the ignition or the passive key, press the **SET/RESET** button when this display appears. **ALL SAVED TO CURRENT KEY** appears in the display to confirm that the settings have been saved.

If you do not wish to save the settings, but to use them for one ignition cycle only:

- continue scrolling to the **EXIT** display and exit the menu, or
- drive off directly. The information display will return to the odometer/tripmeter display automatically.

Advanced menu

The **Advanced** menu allows you to adjust the settings for the steering and Durashift CVT transmission individually.

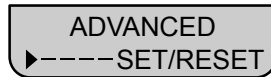

E78512

To enter the **Advanced** menu, scroll to this display using the rotary control and press the **SET/RESET** button.

The following sub-menus/options are available in the **Advanced** menu:

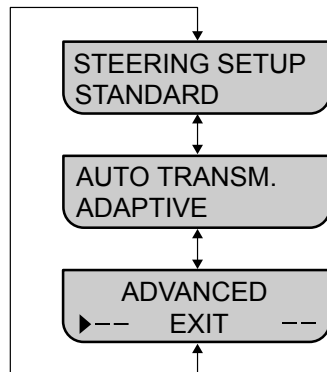

E78513

Information displays

- Steering setup
- Automatic transmission setup
- Advanced – Exit

For information on how to save the settings, see **Saving the settings**.

Steering setup menu

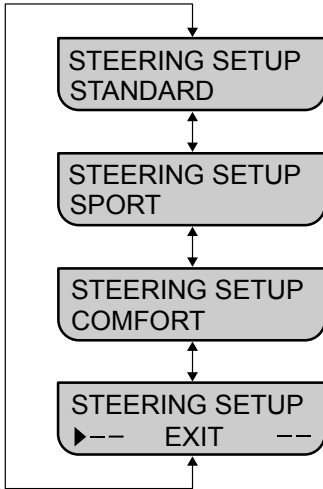

The display shows the setting currently selected. To choose a different setting, press the **SET/RESET** button. Then use the rotary control to scroll through the available settings and press the **SET/RESET** button to select the desired setting. The tick appears in the display of the setting which is selected.

To exit the **Steering setup** menu, scroll to the display **Steering setup - Exit** and press the **SET/RESET** button.

Automatic transmission menu

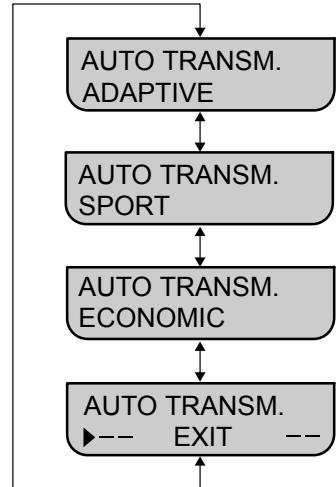

E78515

The display shows the setting currently selected. To choose a different setting, press the **SET/RESET** button. Then use the rotary control to scroll through the available settings and press the **SET/RESET** button to select the desired setting. The tick appears in the display of the setting which is selected.

To exit the **Automatic transmission setup** menu, scroll to the display **Auto transm. - Exit** and press the **SET/RESET** button.

Advanced – Exit



E78516

Information displays

To exit the **Advanced** menu, scroll to this display and press the **SET/RESET** button.

Language setting

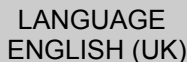

LANGUAGE
ENGLISH (UK)

E78517

A choice of eleven languages is available:

English (UK), German, Italian, French, Spanish, Turkish, Russian, Dutch, Polish, Swedish, Portuguese.

Scroll to this display using the rotary control and press the **SET/RESET** button to select the desired language. Turn the rotary control to save the setting and exit the menu.

Clock setting

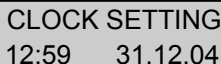

CLOCK SETTING
12:59 31.12.04

E78490

This display is only present on vehicles equipped with a programmable auxiliary heater but no Ford audio or navigation system. If the vehicle is equipped with a Ford audio or navigation system, the time is set on the audio or navigation system. See separate handbook.

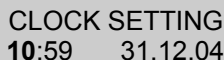

CLOCK SETTING
10:59 31.12.04

E78518

Scroll to this display using the rotary control and press **SET/RESET**. The hours start to flash and can be set using the rotary control.

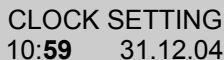

CLOCK SETTING
10:59 31.12.04

E78519

Press the **SET/RESET** button to confirm the setting and move to the minutes.

Proceed in the same way to set the minutes and the date.

After setting the year and pressing **SET/RESET**, the time and date are stored.

Units of measure



MEASURE UNITS
METRIC

E78520



MEASURE UNITS
IMPERIAL

E78521

To toggle between metric and imperial units, scroll to this display and press the **SET/RESET** button.

Toggleing the units of measure using this display will affect the following displays:

- Distance to empty
- Average fuel consumption
- Instantaneous fuel consumption
- Average speed

Information displays

- Outside air temperature
- The temperature display in the automatic climate control.

The units of measure for outside air temperature and the automatic climate control can be toggled independent of the other displays. See **General information** (page 104).

Deactivating the key free function

Note: In order to deactivate and activate the key free function, the spare key must be inserted into the ignition switch and the ignition must be switched on (position **II**).



KEY FREE
ON ✓/OFF

E78522

In the **Your settings** menu, scroll to this display. A tick next to **ON** confirms that the key free function is activated.



KEY FREE
ON /OFF ✓

E78523

A tick next to **OFF** confirms that the key free function is deactivated.

Press the **SET/RESET** button to toggle the function on and off.

Information displays

Auxiliary heater programming

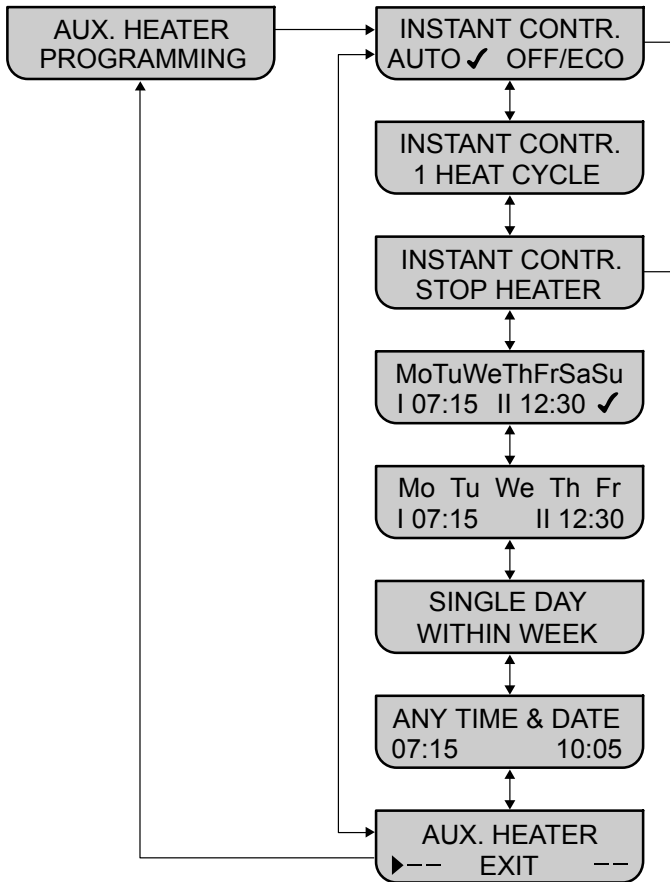

E78524

See **Auxiliary heater** (page 133).

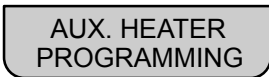

E78525

To programme the auxiliary heater, scroll to this display using the rotary control and press the **SET/RESET** button.

Information displays

Instant control



INSTANT CONTR.
AUTO ✓ OFF/ECO

E78526

The programmable auxiliary heater and the fuel operated heater can be switched on and off manually. The diesel auxiliary heater (PTC electrical heater) cannot be switched on and off manually.

To permanently deactivate the heater, scroll to this display.

A tick next to **AUTO** confirms that the heater can be switched on, either automatically (when necessary), or manually.



INSTANT CONTR.
AUTO OFF/ECO ✓

E78527

A tick next to **OFF/ECO** confirms that the heater is permanently deactivated and cannot be switched on, either automatically, or manually.

To toggle between the two, press **SET/RESET**.



INSTANT CONTR.
1 HEAT CYCLE 🔒

E78528



INSTANT CONTR.
STOP HEATER 🔒

E78529

If **OFF/ECO** is selected, a lock symbol will appear in the other displays, indicating that these functions are currently unavailable.



INSTANT CONTR.
1 HEAT CYCLE ✓

E78530

To switch on the programmable auxiliary heater or fuel operated heater, scroll to this display and press **SET/RESET**. The cursor will change to a tick. The tick in this display confirms that the heater is now activated and will perform one heating cycle.

AUX. HEATER ON will appear in the display.



INSTANT CONTR.
STOP HEATER ✓

E78531

To switch off the programmable auxiliary heater or fuel operated heater during a heating cycle, scroll to this display and press **SET/RESET**. The cursor will change to a tick. The tick in this display confirms that the heater is now deactivated.

AUX. HEATER OFF will appear in the display.

Programme times

Note: The programmed time is the time at which you wish the vehicle to be warm and ready to drive, not the time at which the heater switches on.

Information displays

Note: Times must be programmed at least 70 minutes in advance of the time you wish to set.

Note: The time and date must be correctly set on the audio/ navigation system or on the information display. See **Clock setting**.

Four functions are available for setting the times at which the vehicle should be warmed up:

Seven days in the week

Mo Tu We Th Fr
I 08:30 II 15:45

E78532

One or two times can be programmed for every day of the week.

Five days in the week

Mo Tu We Th Fr
I 07:15 II 12:30

E78533

One or two times can be programmed for the days Monday to Friday.

Single day within week

SINGLE DAY
WITHIN WEEK

E78534

One or two times can be programmed for one particular day of the week.

Any time and date

ANY TIME & DATE
12:59 ; 30.11

E78535

One time can be programmed for one particular day in the next 12 months from the date of programming.

Programming procedure for Seven days in the week, Five days in the week, Single day within week:

In the **Auxiliary heater programming** menu, scroll to the relevant display using the rotary control and press the **SET/RESET** button.

MONDAY
I 08:30 II 17:45

E78536

TUESDAY
I 08:30 II 17:45

E78537

When programming the function **Single day within week**, choose the day using the rotary control and press **SET/RESET**.

The first programme time will flash.

Press **SET/RESET** and the hours will flash.

Set the hours with the rotary control.

Press **SET/RESET** and the minutes will flash.

Information displays

Set the minutes with the rotary control.

Press **SET/RESET** and the second programme time will flash. Repeat to set the second programme time.

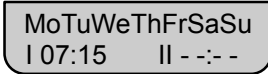

E78538

Note: If only one programme time is desired, select dashes when scrolling through the hours and minutes. These appear between 23 and 00 hours and between 59 and 00 minutes.

After setting the minutes of the second programme time, press **SET/RESET** and the cursor will flash.

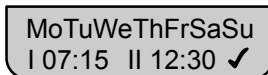

E78539

Press **SET/RESET** again and the cursor will change to a tick. The tick confirms that the time schedules are now stored and that the heater will have the vehicle warmed up at the times set.

Note: It is not possible to select the **Seven days in the week**, **Five days in the week** and **Single day within week** functions simultaneously as only one set of times can be programmed for each day.

If programme times for one of these functions are stored and active, confirmed by a tick, a lock symbol will appear in the programming display of the other two, showing that these functions cannot be activated. To activate one of the other two functions, first deactivate the function currently active by deleting the tick.

To deactivate the function, scroll to the relevant display and press **SET/RESET** repeatedly until the tick flashes. Press **SET/RESET** again to delete the tick and deactivate the function.

Programming procedure for Any time and date

In the **Auxiliary heater programming** menu, scroll to this display using the rotary control and press the **SET/RESET** button.

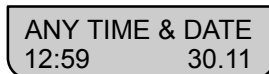

E78540

The hours will flash.

Set the hours with the rotary control.

Press **SET/RESET** and the minutes will flash.

Proceed in the same way to set the minutes, the month and the day.

After setting the day, press **SET/RESET** and the cursor will flash.



E78541

Information displays

Press **SET/RESET** to confirm the settings. The cursor will change to a tick. The tick confirms that the time schedule is now stored and the heater will have the vehicle warmed up at the time set.

To deactivate the function, scroll to this display and press **SET/RESET** repeatedly until the tick flashes. Press **SET/RESET** again to delete the tick and deactivate the function.

Chime deactivation

The following chimes can be deactivated:

- Exterior lights on when the driver's door is opened.
- **SET/RESET** button press.
- The chime which signals the appearance of a warning message (with the exception of messages with a red warning lamp).

A rectangular display with rounded corners. The text reads "MESSAGE CHIMES" on the top line, "ON" followed by a checkmark symbol on the bottom left, and "/OFF" on the bottom right.

E78542

A tick next to **ON** confirms that the chimes are activated.

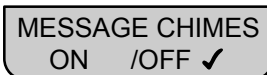
A rectangular display with rounded corners. The text reads "MESSAGE CHIMES" on the top line, "ON" on the bottom left, and "/OFF" followed by a checkmark symbol on the bottom right.

E78489

A tick next to **OFF** confirms that the chimes are deactivated. To toggle the chimes on and off press the **SET/RESET** button.

Your settings - Exit

A rectangular display with rounded corners. The text reads "YOUR SETTINGS" on the top line. On the bottom line, there is a right-pointing arrow followed by two dashes, the word "EXIT" in the center, and two more dashes followed by a left-pointing arrow.

E78543

To exit the **Your settings** menu, scroll to this display and press **SET/RESET**.

Information displays

INFORMATION MESSAGES

Information displays

Message	Warning lamp	System
HIGH ENGINE TEMPERATURE	red	Cooling system.
LOW BRAKE FLUID LEVEL	red	Brakes.
ENGINE SYSTEMS FAULT	red	Engine. Stop the vehicle as soon as safely possible and switch off the engine immediately. Have the engine checked by an expert immediately.
BRAKE LIGHT FAULT	red	Brake lamp switch. The vehicle can be driven as normal. However, cruise control cannot be switched on. Have the system checked by an expert as soon as possible.
ACCELERATION REDUCED	red	Electronic acceleration control (EAC). The vehicle can be driven but the acceleration rate will be noticeably reduced. Maximum vehicle speed will be maintained. Have the system checked by an expert as soon as possible.
SPEED LIMITED MODE	red	Electronic acceleration control (EAC). The engine speed will drop to idle and there will be no accelerator pedal response. Once the brake pedal is pressed and released, the engine speed will rise to between 1 500 and 4 000 rpm and the vehicle can be driven safely up to a maximum of 56 km/h (35 mph). Pressing the brake pedal will reduce the engine speed back down to idle. Have the system checked by an expert as soon as possible.
DRIVER DOOR OPEN	red	Locks.

Information displays

Message	Warning lamp	System
DRIVER SIDE REAR DOOR OPEN	red	Locks.
PASSENGER DOOR OPEN	red	Locks.
PASSENGER SIDE REAR DOOR OPEN	red	Locks.
LUGGAGE COMP. OPEN	red	Locks.
BONNET OPEN	red	Locks.
PASSIVE KEY NOT DETECTED	red	Key free system.
PASSIVE KEY OUTSIDE CAR	red	Key free system.
STOP VEHICLE - ROOF OPERATION	red	Stop vehicle to operate. Roof opening or closing sequence was enabled during vehicle stand still, driving started.
LOW WASHER FLUID LEVEL	amber	Screen washer.
ESP SYSTEM FAULT	amber	Stability control (ESP).
REMOTE KEY BATTERY LOW	amber	Locks.
STEERING ASSIST FAILURE	amber	Power steering. Full steering will be maintained but you will need to exert greater force on the steering wheel. Have the system checked by an expert as soon as possible.
TRANSMISSION MALFUNCTION	amber	Automatic transmission.
PASSIVE KEY IN LUGG. COMP.	amber	Key free system.
ADAPTIVE FRONT LIGHT FAILURE	amber	Adaptive front lighting system (AFS).
CLOSE LUGGAGE COMP. SEPARATOR	amber	Deploy the luggage compartment separator or close the luggage compartment lid.
ROOF NEEDS ENGINE RUNNING	amber	Start the engine to operate.
ROOF MALFUNCT. SERVICE REQD.	amber	Permanent malfunction. Have your vehicle checked by a properly trained technician.

Information displays

Message	Warning lamp	System
COMPLETE ROOF OPERATION	amber	Opening or closing sequence not complete. Convertible top is not locked. Press the convertible top switch until sequence is complete.
PASSIVE KEY LEFT INSIDE	-	Key free system.
PLEASE ENGAGE STEERING LOCK	-	Key free system.
PRESS BRAKE TO START ENGINE	-	Key free system.
PRESS CLUTCH AND START ENGINE	-	Key free system.
ENGAGEMENT IN PROGRESS/ PRESS BRAKE PEDAL	-	Durashift CVT transmission.
ROOF OPERATING	-	Progress information.

Climate control

PRINCIPLE OF OPERATION

Outside air

Keep the air intakes forward of the windscreen free from obstruction (snow, leaves etc.) to allow the climate control system to function effectively.

Recirculated air

CAUTION

 We recommend that you do not use recirculated air for more than 30 minutes.

The air currently in the passenger compartment will be recirculated. Outside air will not enter the vehicle.

Heating

Heating performance depends on the temperature of the engine coolant.

Air conditioning

Note: The air conditioning operates only when the temperature is above 4°C.

Note: If you use the air conditioning, the fuel consumption of your vehicle will be higher.

Air is directed through the coolant heat exchanger where it is cooled. Humidity is extracted from the air to help keep the windows free of mist. The resulting condensation is directed to the outside of the vehicle and it is therefore normal if you see a small pool of water under your vehicle.

General information on controlling the interior climate

Fully close all the windows.

Warming the interior

Direct the air towards your feet. In cold or humid weather conditions, direct some of the air towards the windscreen and the door windows.

Cooling the interior

Direct the air towards your face.

AIR VENTS

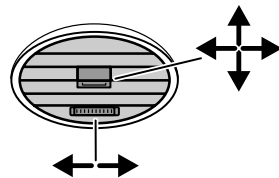

E78809

Climate control

MANUAL CLIMATE CONTROL

Air distribution control

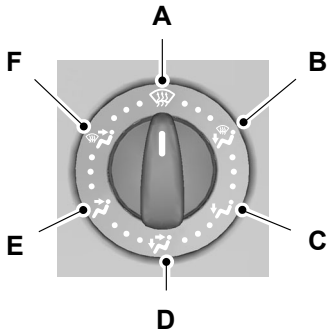

E71379

- A Windscreen
- B Footwell and windscreen
- C Footwell
- D Face level and footwell
- E Face level
- F Face level and windscreen

The air distribution control can be set to any position between the symbols.

A minor portion of the air stream is always directed towards the windscreen.

Temperature control

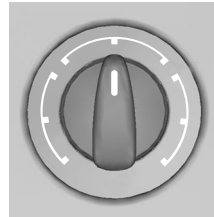

E75471

- Blue Cold
- Red Warm

Blower

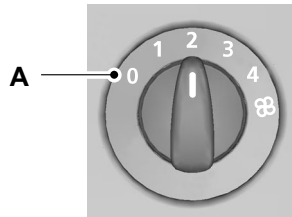

E75470

- A Off

To increase the blower speed, select a higher position.

With the blower turned off, the windscreen may mist up.

Climate control

Recirculated air

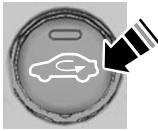

E73059

Press the switch to toggle between outside air and recirculated interior air. The light in the switch indicates operation.

Rapid windscreen defrosting/demisting

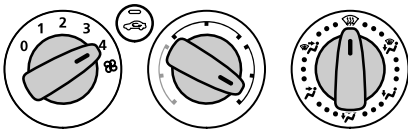

E77937

Recirculated air is switched off automatically. If necessary turn the heated windows on.

Rapid heating of vehicle interior

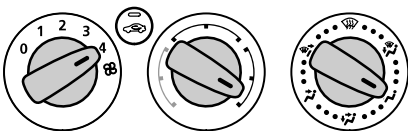

E77935

Ventilation

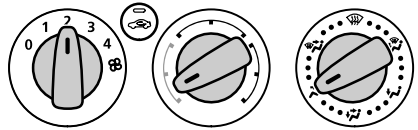

E77936

Set the air distribution control to face level or face level and footwell. Set the blower to any position. Open the air vents to suit individual requirements.

Air conditioning

Switching the air conditioning on and off

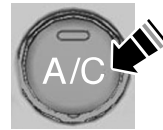

E73054

Note: For the air conditioning to operate the engine must be running.

Press the switch to turn on or off. The lamp in the switch indicates when air conditioning is selected.

If the blower is turned to position **0**, the air conditioning will turn off. When the blower is turned on again, the air conditioning will reactivate automatically.

Climate control

Cooling with outside air

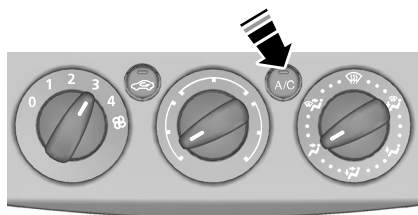

E71380

Switch the air conditioning on.

Rapid cooling of the vehicles interior

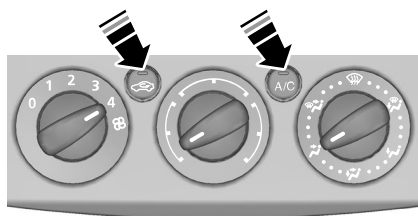

E71381

Switch the air conditioning on.

Windscreen defrosting/demisting

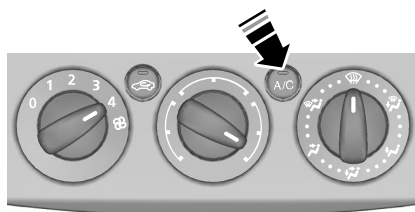

E71382

Outside air will flow into the vehicle. As long as the air distribution control is set to windscreen, the air conditioning will be turned on automatically. Make sure the blower is on.

The lamp in the **A/C** switch illuminates during defrosting/demisting.

The air conditioning and recirculated air can be switched on and off while the air distribution control is set to windscreen.

Reducing air humidity

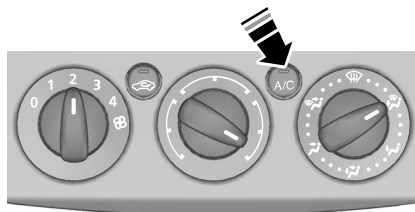

E71383

Climate control

Switching the air conditioning on extracts humidity from the air and demists the windows faster.

AUTOMATIC CLIMATE CONTROL

Note: Note: The automatic climate control system can be operated via the navigation system touchscreen. See separate handbook.

The temperature, amount and distribution of the air flow are controlled automatically and adjusted according to the driving and weather conditions. The recommended system settings for all seasons are 22 °C and **AUTO** mode (the air conditioning is switched on). The individual settings can be adjusted as necessary. Avoid adjusting the settings when the vehicle interior is extremely hot or cold. The automatic climate control system adjusts to the current circumstances automatically. For the system to function properly, the side and centre vents should be fully open.

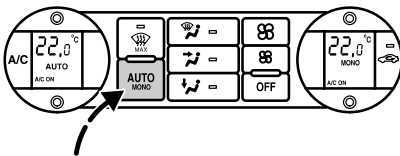

E78005

Pressing the **AUTO** button once switches on the **AUTO** mode.

The sensor which measures the interior temperature is located in the centre of the instrument panel. The sunload sensor is located on top of the instrument panel. The sensors should not be covered by any objects.

At low outside temperatures, when the system is in **AUTO** mode, the air stream will be directed to the windscreen and the side windows as long as the engine is cold.

Setting the temperature

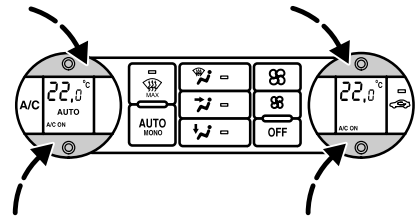

E78006

- Blue Reduces temperature
- Red Increases temperature

The temperature can be set between 16 °C and 28 °C in steps of 0.5 °C using the buttons. In position **LO** (below 16 °C) the system will switch to permanent cooling, in **HI** (above 28 °C) to permanent heating, and not regulate a stable temperature.

Climate control

Mono mode

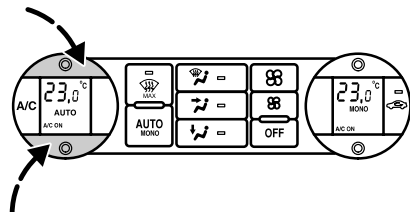

E78007

In **AUTO** mode, the temperature settings for both the driver's and passenger's side are linked. If the temperature is adjusted using the buttons on the driver's side, the settings will also be adjusted to the same setting on the passenger's side. In **MONO** mode, **MONO** appears in the right-hand display.

Setting different temperatures for the driver's and passenger's side

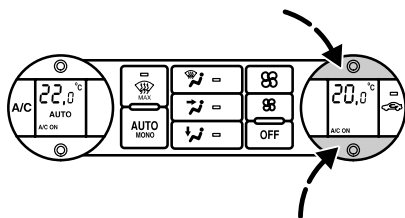

E78008

Press the temperature buttons on the passenger's side to select the temperature for the passenger's side. The temperature for the driver's side will remain unchanged.

The temperature settings for each side are shown in the displays and **MONO** will extinguish from the display. It is possible to set a temperature difference of up to 4 °C.

If one of the sides is set to **HI** or **LO**, both sides will be set to **HI** or **LO**.

To toggle Mono mode on and off

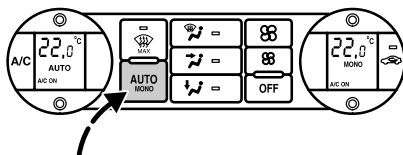

E78009

To toggle **MONO** mode on and off, press and hold the **AUTO** button for at least two seconds. If the system was in **MONO** mode, **MONO** will extinguish from the display.

The driver and passenger side temperatures can now be adjusted independently of one another.

To return to **MONO** mode, press and hold the **AUTO** button for at least two seconds. **MONO** reappears in the display and the passenger's side temperature will be adjusted to the driver's side temperature.

Climate control

Operating the automatic climate control manually

Blower

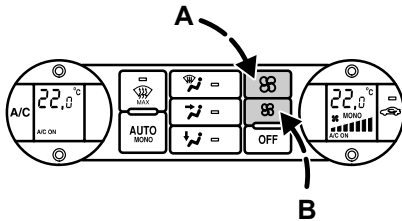

E78010

- A Increases the blower speed
- B Reduces the blower speed

The blower setting is indicated in the right-hand display.

To return to **AUTO** mode, press the **AUTO** button.

Air distribution

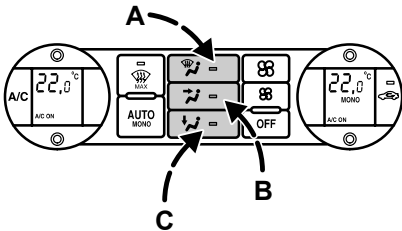

E78011

- A Windscreen
- B Face level
- C Footwell

To adjust air distribution, press the desired button. Any combination of settings can be selected simultaneously.

Windscreen defrosting/demisting

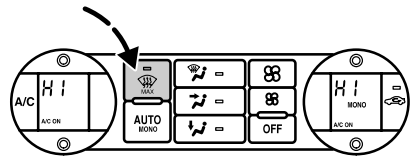

E78012

Outside air will flow into the vehicle. Air conditioning is automatically selected. Recirculated air cannot be selected. The blower speed and the temperature control operate automatically and cannot be adjusted manually. The blower is set to high speed and the temperature to **HI**.

The heated windows switch on automatically and switch off after a short time.

The auxiliary heater will be switched on automatically if needed. This is indicated by the message **AUX. HEATER ON** in the information display.

To return to **AUTO** mode, press **AUTO** or the button(s) with illuminated indicators.

Switching the air conditioning on and off

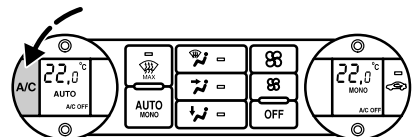

E78013

Climate control

Press the **A/C** button to switch the air conditioning on and off. **A/C OFF** appears in both displays when the air conditioning is switched off. **A/C ON** appears in both displays when the air conditioning is switched on.

Recirculated air

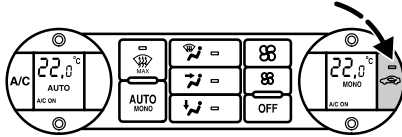

E78014

Press the recirculated air control to toggle between outside air and recirculated air.

Automatic recirculated air control

When the system is in **AUTO** mode and the interior and exterior temperatures are quite hot, recirculated air is selected automatically to maximise cooling of the interior.

Once the selected temperature is reached, the system will automatically change to the outside air position. The indicator in the button does not illuminate during the automatic operation.

Switching the automatic climate control off

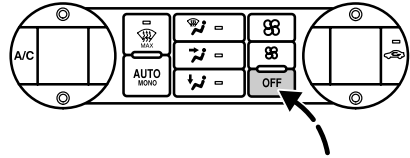

E78015

Press **OFF** to switch off the automatic climate control.

The heating, ventilation and air conditioning system is switched off and recirculated air is selected.

Press any button to switch the system back on.

HEATED WINDOWS AND MIRRORS

Heated windows

Use for quick defrosting or demisting of the windscreen or rear window. It should be switched on only if necessary.

Heated windscreen

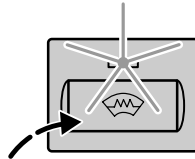

E78039

Climate control

The system operates only when the engine is running and also defrosts the front washer jets. Press the switch to turn on or off. The lamp in the switch indicates the operation.

The heating system switches off automatically after a short period of time.

Heated rear window

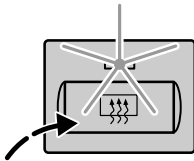

E78040

Switch on the ignition first.

Press the switch to turn on or off. The lamp in the switch indicates operation.

The heating system switches off automatically after a short period of time.

Heated exterior mirrors

Electrically operated door mirrors also have a heating element to clear the glass. This system operates when the heated rear window is switched on.

AUXILIARY HEATER

Programmable auxiliary heater

WARNINGS

 The programmable auxiliary heater must not be operated in enclosed spaces, at filling stations or near sources of combustible vapours or dust.

 The programmable auxiliary heater should be switched on for approximately 10 minutes at least once a month all year round. This prevents the water pump and heater motor from seizing.

 To avoid corrosion, the coolant in your vehicle should contain at least 10 % antifreeze all year round.

Note: The programmable auxiliary heater will only operate if there is at least 7.5 litres of fuel in the fuel tank.

Note: The heating depends on the outside air temperature.

Note: It is possible that when the programmable auxiliary heater is activated, exhaust fumes may come from under the sides of the vehicle. This is normal.

Note: On vehicles with manual climate control the heating of the vehicle interior is dependent on the temperature, air distribution and blower control settings.

Climate control

The programmable auxiliary heater operates independently of the vehicle heater by heating the engine's coolant circuit. It is fed from the vehicle fuel tank.

Used properly, the programmable auxiliary heater provides the following benefits:

- It preheats the interior of the vehicle.
- It keeps the windows clear of ice in the event of frost and prevents condensation.
- It avoids cold starts and allows the engine to reach operating temperature sooner.

The programmable auxiliary heater may also be used while the vehicle is in motion to help the vehicle heater and warm up the interior more quickly.

To prevent the battery from discharging:

- Once the programmable auxiliary heater has performed one heating cycle, the next programmed heater time will only be carried out if the vehicle's engine has been started in between.
- After a heating cycle, the vehicle should be driven for at least the period of the heating cycle.

Programming the auxiliary heater

The auxiliary heater is programmed using the information display. See **Information displays** (page 104).

Auxiliary heater

The diesel auxiliary heater (PTC electrical heater) aids in warming the engine and the interior compartment on vehicles with diesel engines. It is automatically switched on or off depending on the outside temperature, the coolant temperature and the alternator load.

Fuel operated heater

The fuel operated heater aids in warming the engine and the interior compartment on vehicles with a petrol or diesel engine. It is automatically switched on or off depending on the outside temperature and the coolant temperature, unless it has been deactivated by the driver.

When the fuel operated heater is operating, a message appears in the information display.

The fuel operated heater can be deactivated using the information display. See **Information displays** (page 104).

Climate control

ELECTRIC SUNROOF

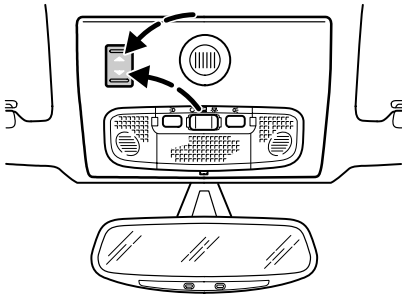

E78054

WARNING

 Before operating the electric sunroof you should verify it is free of obstructions and ensure that children and/or pets are not in the proximity of the sunroof opening. Failure to do so could result in serious personal injury. It is the primary responsibility of the supervising adults to never leave a child unattended in a vehicle and to never leave the keys in an unattended vehicle.

Note: When the switches are operated often during a short period of time, the system might become inoperable for a certain time to prevent damage due to overheating.

Note: The electric sunroof can also be operated with the ignition off via the global opening and global closing function. See **Global opening and closing** (page 51).

There are two ways of opening the sunroof – the rear of the sunroof lifts open or the sunroof opens from the front, sliding back under the roof. The sunroof opens and closes whilst the switch is pressed.

Switch on the ignition to operate the electric sunroof.

The power sunroof is operated by a switch located between the sun visors.

Opening and closing the sunroof

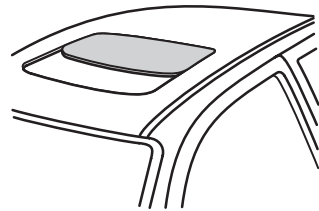

E72188

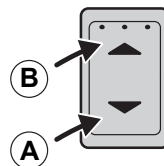

E72185

- A Press to close
- B Press to open

Climate control

Tilting the sunroof

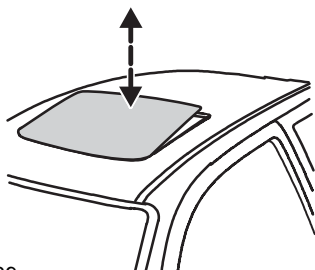

E72189

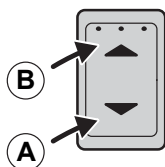

E72185

- A Press to open
- B Press to close

Opening and closing the sunroof automatically

Note: When opening automatically, the sunroof will stop about 8 cm from the fully opened position. This position reduces the buffeting noise which is sometimes heard when the sunroof is fully open. The sunroof will only stop automatically in this position when the sunroof is opened automatically.

To open or close the sunroof automatically press either side of the switch to the second action point and release it completely. Press again to stop.

When the closed position is reached, the sunroof stops automatically.

Sunroof anti-trap protection

WARNINGS

 The anti-trap function is deactivated until the memory has been reset. Careless closing of the window can cause injuries.

 Careless closing of the electric sunroof can override the anti-trap protection and cause injuries.

The sunroof will stop automatically while closing and reverse some distance if there is an obstacle in the way.

To override anti-trap protection when there is a resistance, e. g. in the winter, proceed as follows:

WARNING

 While the sunroof is being closed for the third time, the anti-trap function is disabled. Make sure there are no obstacles in the way of the closing sunroof.

Climate control

Close the sunroof a third time to the resistance. The anti-trap function is disabled and the sunroof cannot be closed automatically. The sunroof will override the resistance and can then be closed fully.

If the sunroof does not close after the third attempt, have it checked by an expert.

Sunroof safety mode

WARNING



The anti-trap function is not active during this procedure. Make sure that there are no obstacles in the way of the closing sunroof.

If the system detects a malfunction, it enters a safety mode. The sunroof will move for only about 0.5 seconds at a time and then stop again. Close the sunroof by pressing the button again when the sunroof stops moving. When the rear of the sunroof is lifted, lift the rear all the way and then close the sunroof. Have the system checked by an expert immediately.

Sunroof relearning

WARNING



The anti-trap function is not active during this procedure. Make sure that there are no obstacles in the way of the closing sunroof.

In case the sunroof no longer closes properly, follow this relearning procedure:

- Tilt the rear of the sunroof as far as possible. Release the button.
- Press and hold the same button again for 30 seconds until you see the sunroof move.
- Release the button and immediately press and hold it again. The sunroof will close, open fully and then close again. Do not release the button before the sunroof has reached the closed position for the second time.

If the button is not pressed continuously, the relearning function will be interrupted. Start the procedure once more from the beginning.

Seats

SITTING IN THE CORRECT POSITION

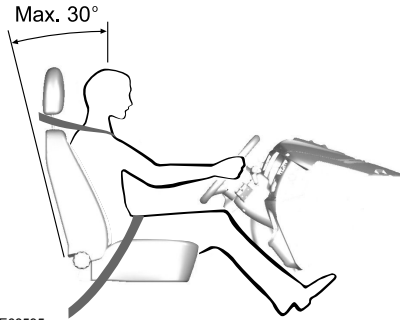

E68595

WARNINGS



Do not adjust the seats when the vehicle is moving.



Only when you use the seat belt properly, can it hold you in a position that allows the airbag to achieve its optimum effect.

When you use them properly, the seat, head restraint, seat belt and airbags will provide optimum protection in the event of a collision. We recommend that you:

- sit in an upright position with the base of your spine as far back as possible.
- do not recline the seatback more than 30 degrees.
- adjust the head restraint so that the top of it is level with the top of your head.

- keep sufficient distance between yourself and the steering wheel. We recommend a minimum of 254 millimetres (10 inches) between your breastbone and the airbag cover.
- hold the steering wheel with your arms slightly bent.
- bend your legs slightly so that you can press the pedals fully.
- position the shoulder strap of the seat belt over the centre of your shoulder and position the lap strap tightly across your hips.

Make sure that your driving position is comfortable and that you can maintain full control of your vehicle.

MANUAL SEATS

All vehicles

WARNINGS



Do not use any accessory seat covers that are not specifically designed for seats with side airbags. These seat covers must be fitted by properly trained technicians.



Do not adjust the seats while the vehicle is moving.

Seats

Moving the seats forwards or backwards

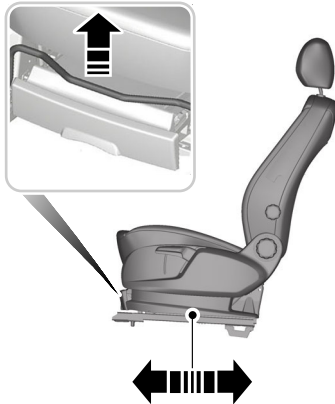

E70728

Pull the lever. Rock the seat to engage the catch.

Adjusting the height of the driver's seat

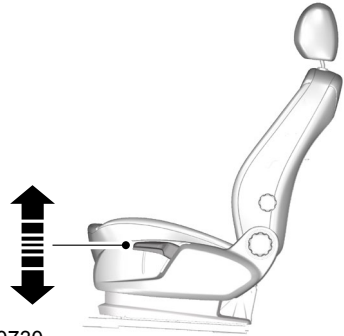

E70730

Each pull or press on the lever will raise or lower the height by a small amount.

Adjusting the lumbar support

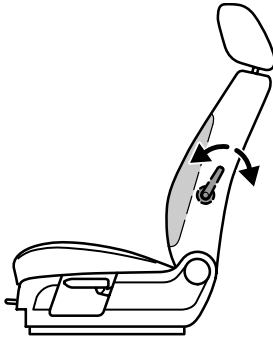

E78058

Adjusting the angle of the seatback

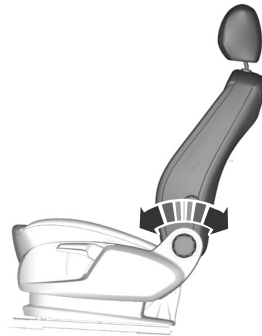

E70731

When the seats are slid fully forward the seatbacks can be fully reclined.

Seats

3-door

Folding the seatback forwards

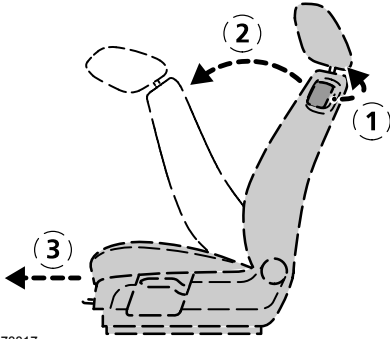

E78817

Pull the locking lever **1** and fold the seatback forwards until it locks into the folded position **2**.

Without pulling the locking lever, slide the seat forwards **3**.

Returning the seatback to the seating position

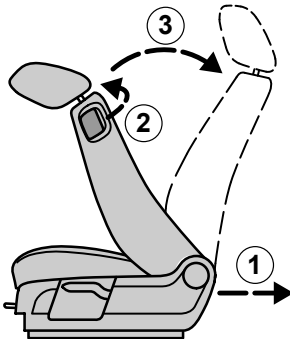

E78818

WARNING

 Do not place any objects behind the seatback which could prevent the engagement of the seat lock.

Note: The driver's seat will return to its original position.

Slide the seat backwards **1**.

Pull the locking lever **2** and fold back the seatback until it locks with a distinct click **3**.

FocusST

8/10 way Recaro seats

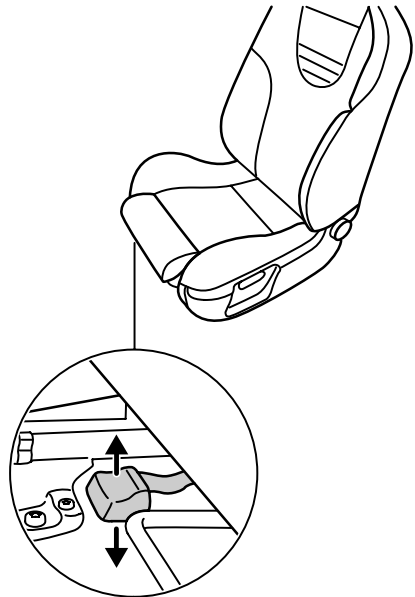

E78815

Seats

Each pull or press on the lever will raise or lower the cushion angle by a small amount.

Recaro leather seat

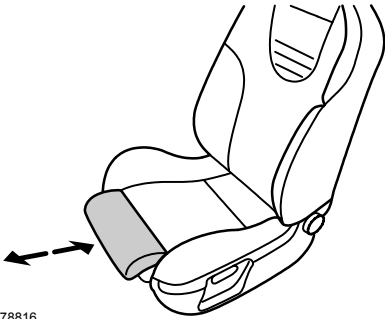

E78816

To adjust the length of the seat cushion, press the locking handle underneath the cushion extension and slide the extension forwards or rearwards.

ELECTRIC SEATS

2-way electric seat

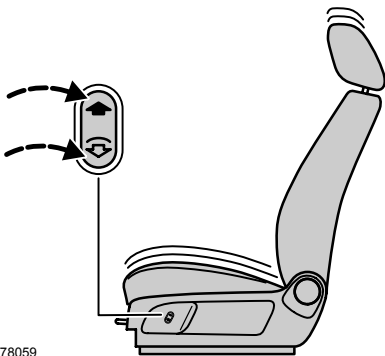

E78059

Seats

6-way electric seat

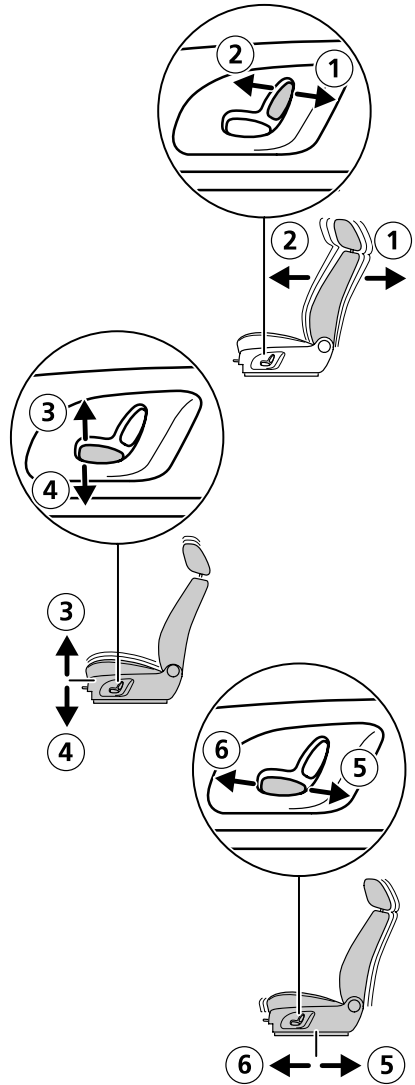

E78060

Seats

HEAD RESTRAINTS

Adjusting the head restraint

WARNINGS

 Raise the rear head restraint when the rear seat is occupied by a passenger.

 When using a forward facing child restraint on a second or third row seat, always remove the head restraint from that seat.

Adjust the head restraint so that the top of it is level with the top of your head.

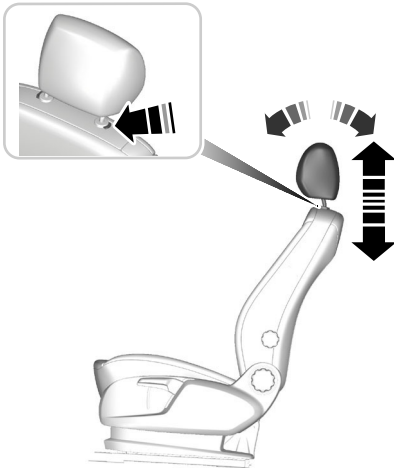

E71879

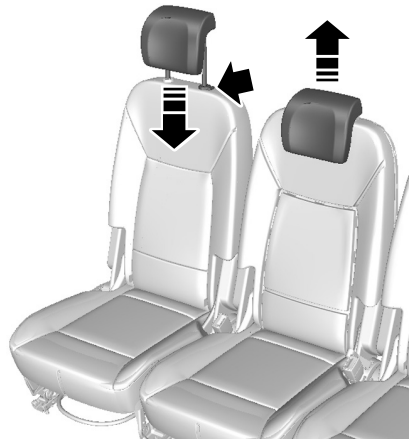

E72593

Adjust the angle of a four-way front head restraint by swivelling it forwards or backwards.

Removing the head restraint

Press the locking buttons and remove the head restraint.

Seats

REAR SEATS

Folding the rear seatbacks forwards

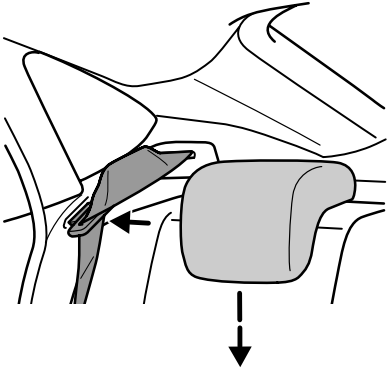

E78819

Insert the seatbelt tongues into the retaining slots.

Lower the head restraints.

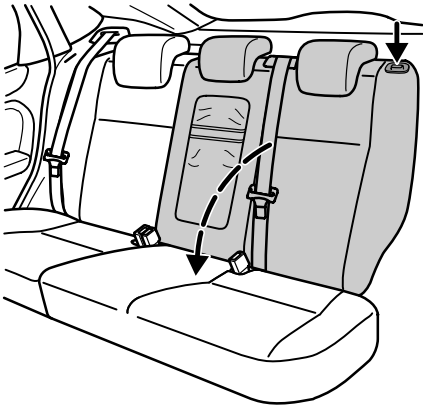

E78820

Push the unlocking button on the seatback and fold the seatback forwards.

When returning the seatbacks to the upright position, ensure that they engage in their outer latches.

The seatbelts must be forward of the seatback.

Folding the seat cushions and seatback forwards

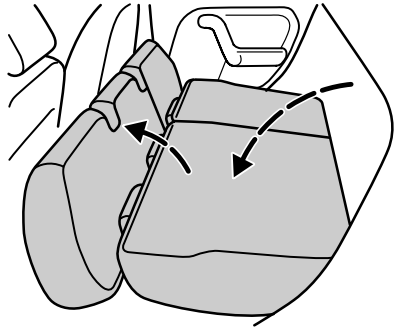

E78821

Insert the seatbelt tongues into the retaining slots.

Insert your fingers between the seat cushion and seatback and fold the seat cushion forwards.

Push down the rear head restraint(s) and fold the seatback(s) forwards.

Note: When the red marking in the unlocking button is visible, the seatback is not fully engaged. Release the seatback and repeat the procedure until the red marking is no longer visible.

Seats

When returning the seats to the seating position, the seatback must engage in the latches.

The seat belts must be forward of the seatback.

HEATED SEATS

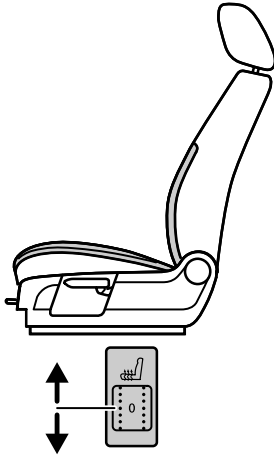

E78061

WARNING



Heating with the engine off will drain the battery.

The heated front seats are operated by rotary controls in the instrument panel.

The maximum temperature is reached after five or six minutes. It is regulated thermostatically.

The seat heating will operate only when the ignition is in position II.

Convenience features

SUN VISORS

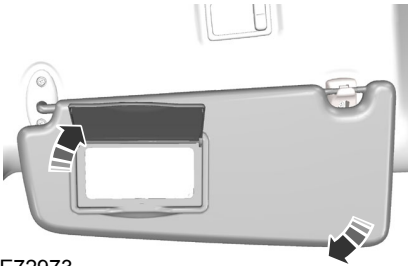

E72973

SUN BLINDS

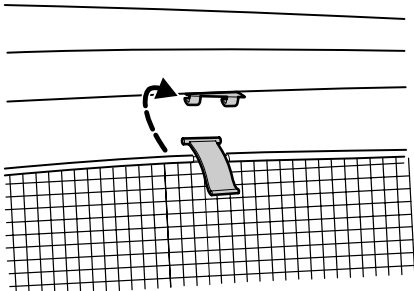

E78057

Pull the sun blind up and attach it to the hooks.

INSTRUMENT LIGHTING DIMMER

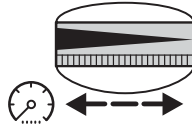

E70454

CIGAR LIGHTER

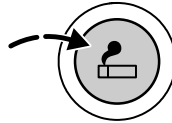

E78055

WARNING

 Never hold the lighter in as this will result in damage. Always remove the lighter as a precaution when children are left alone in the vehicle.

To use the lighter, press it in and wait until it pops out automatically. The lighter will also operate when the ignition is switched off.

Other appliances can be connected to the cigar lighter power point.

When connecting appliances, use only specified connectors from the Ford Accessory range or connectors for use with SAE standard sockets.

Convenience features

ASHTRAY



To empty, pull out the complete ashtray.

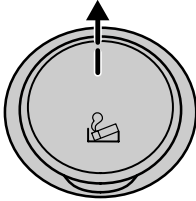

E78837

Pull the cover to open.

To empty, gently pull up on the open lid and extract the complete ashtray.

AUXILIARY POWER SOCKETS

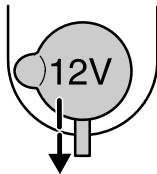

E78056

Auxiliary power sockets are located in the centre console and in the luggage compartment.

The auxiliary power socket can also be used to power 12 volt appliances having a current rating of maximum 10 amperes. However, if the engine is not running, this will cause the battery to discharge.

When connecting appliances, use only specified connectors from the Ford Accessory range or connectors for use with SAE standard sockets.

CUP HOLDERS

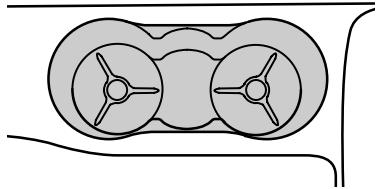

E78838

WARNING



To avoid scalding, never place hot drinks in the cup holder.

GLOVE BOX

Cooled glove box

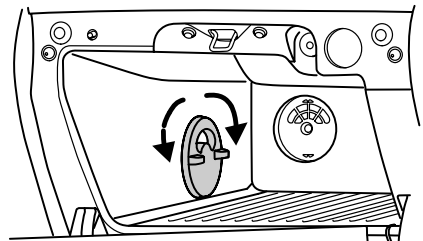

E78839

Convenience features

The glove box can be cooled using air from the air conditioning system. When the air conditioning is switched on, the air flow entering the glove box will be cooled. If the air conditioning is switched off, the air flow will be at approximately ambient temperature.

The air flow can be shut off to prevent the flow of cooled air into the vehicle interior.

To turn the air flow on or off, turn the valve in the glove box.

CENTRE CONSOLE

Depending on the equipment fitted, the following features may be incorporated into the console in your vehicle:

Cigar lighter

See **Cigar lighter** (page 146).

Ashtray

See **Ashtray** (page 147).

Auxiliary power socket

See **Auxiliary power sockets** (page 147).

Mobile phone cradle

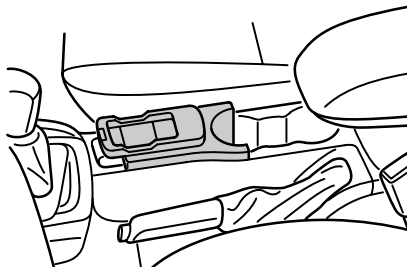

Cup holders

See **Cup holders** (page 147).

Armrest

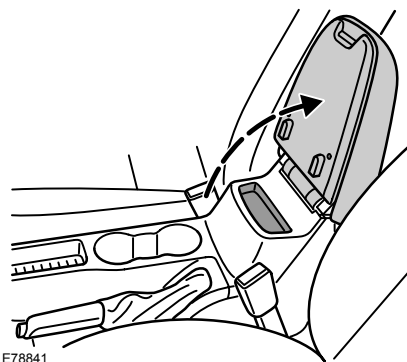

Convenience features

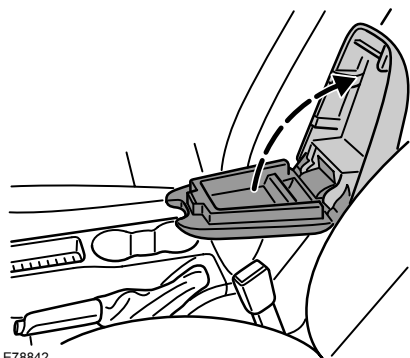

E78842

Storage compartments are incorporated into and under the armrest.

Storage compartment

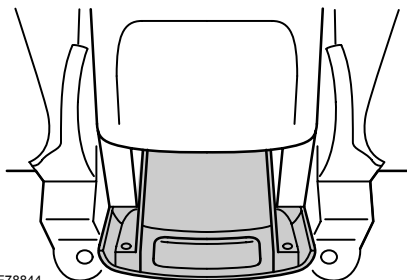

E78844

WARNING

 Do not use the storage compartment as an ashtray.

STORAGE COMPARTMENTS

Front storage compartment

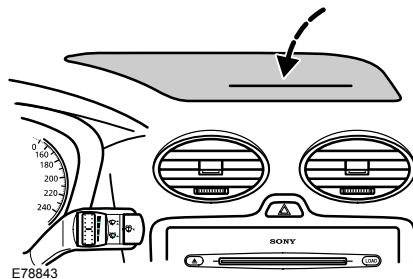

E78843

WARNING

 Never drive with the front storage compartment lid open. This will obscure your vision out of the windscreen. Before setting off, always ensure that the lid is securely engaged.

Note: Avoid keeping heat-sensitive objects and liquids in the front storage compartment.

Pull to open. To close, push the lid down until it engages.

Convenience features

REAR SEAT ARMREST



E78845

TOLL READER

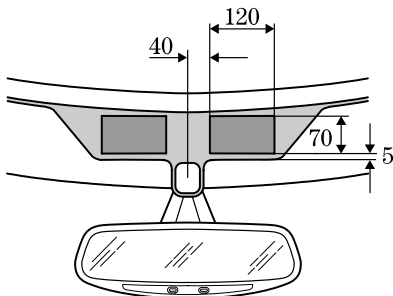

E78729

On vehicles with an anti-heat windscreen, toll readers should be placed in the area as shown (all measurements shown in millimetres), otherwise communication performance with toll stations may be reduced.

The toll reader should be placed on the passenger side to prevent the reader from obscuring the driver's vision (e.g. at traffic lights).

GLASSES HOLDER

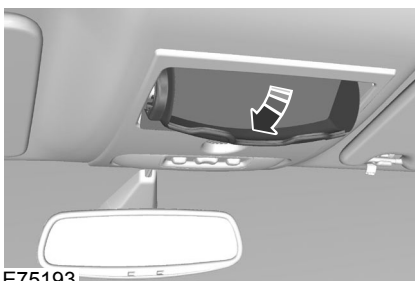

E75193

AUXILIARY INPUT (AUX IN) SOCKET

The AUX IN socket is located in the glove compartment. See separate handbook.

Starting the engine

GENERAL INFORMATION

General points on starting

If the battery has been disconnected the vehicle may exhibit some unusual driving characteristics for approx. 8 kilometres (5 miles) after reconnecting the battery.

This is because the engine management system must realign itself with the engine. Any unusual driving characteristics during this period may be disregarded.

Starting the engine by towing or pushing

WARNING



To prevent damage you must not push or tow start your vehicle. Use booster cables and a booster battery. See **Using booster cables** (page 228).

IGNITION SWITCH

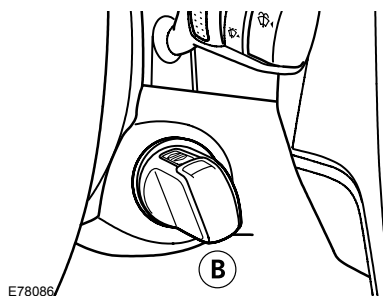
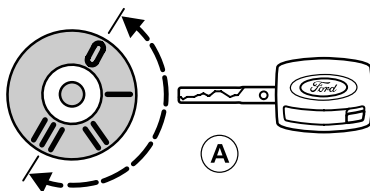

- A Vehicles without the key free system
- B Vehicles with the key free system

Ignition switch positions

Position 0

WARNING



Never return the key to the 0 position when the vehicle is in motion.

Ignition off.

Vehicles without the key free system

Starting the engine

When the key is removed from the ignition switch, the steering column lock will be activated as soon as the steering wheel is turned.

Vehicles with the key free system

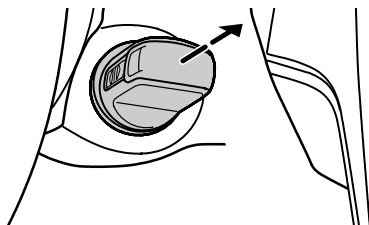

E78087

Note: Pulling out the ignition switch is equivalent to removing the key from the ignition.

Turn the ignition switch to position 0 and pull it out approximately 5 mm.

If the ignition switch is not pulled out, **PLEASE ENGAGE STEERING LOCK** will appear in the information display and a chime will sound when the driver's door is opened.

Position I

Steering unlocked. Ignition and all main electrical circuits are disabled. The ignition key should not be left in this position for too long to avoid discharging the battery.

Position II

Ignition switched on, all electrical circuits operational. Warning and indicator lamps illuminate. This is the key position when driving, and must also be selected when being towed.

Position III

Starter motor activated. Release the key as soon as the engine starts.

STARTING A PETROL ENGINE

All vehicles

WARNING

 If the engine does not start, refer to the instructions regarding the fuel cut-off switch. See **Fuel cut-off switch** (page 199).

Except vehicles with a Flexfuel engine

Cold/hot engine

WARNING

 At temperatures below -20°C , turn the ignition key to position II for at least one second. This ensures that maximum fuel pressure is established.

Depress the clutch pedal fully and start the engine without touching the accelerator.

Starting the engine

If the engine does not start within 15 seconds, wait for a short period and repeat the procedure.

If the engine does not start after **three** attempts wait 10 seconds and follow the **Flooded engine** procedure.

If starting difficulty is experienced at temperatures below -25°C , depress the accelerator pedal $\frac{1}{4}$ to $\frac{1}{2}$ of its travel to assist starting.

Flooded engine

Depress the clutch pedal fully.

Slowly depress the accelerator **fully**, hold it in this position and start the engine.

If the engine does not start repeat the **Cold/hot engine** procedure.

Vehicles with a Flexfuel engine

Starting at low ambient temperatures

When the temperature is expected to be lower than -15°C and the vehicle is filled with bio ethanol E 85, an engine block heater should be used to facilitate starting.

If the temperature is expected to remain below -15°C , it is recommended that you increase the proportion of petrol in the tank by topping up with 95 octane unleaded petrol if the tank is not already full. About 10 litres of petrol will reduce the proportion of bio ethanol E 85 in a $\frac{3}{4}$ full tank from 85% to 70%.

If, at very low temperatures, the tank is filled with only bio ethanol E 85 and there is no way to use an engine block heater, you may experience difficulties starting the engine.

If the engine fails to start, proceed as follows:

1. Depress the accelerator pedal $\frac{1}{3}$ to $\frac{1}{2}$ of its travel.
2. Turn the ignition key to position **III**.
3. Release the ignition key as soon as the engine has started and release the accelerator pedal gradually as the engine speed increases.
4. If the engine fails to start, depress the accelerator pedal fully and repeat steps 2 and 3.

During starting, the fuel injectors are turned off as long as the accelerator pedal is depressed. This can be used to drain excessive fuel from the intake manifold after several unsuccessful starting attempts.

If the battery has been disconnected or after the fuel type has been changed, the idle speed may be irregular. This will improve after 10 to 30 seconds.

Starting the engine

Vehicles with the key free system

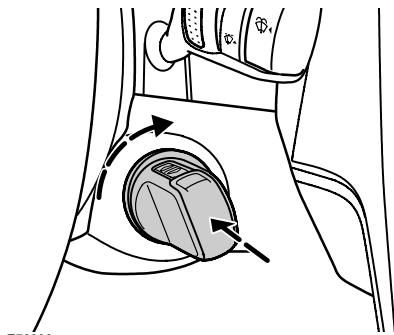

E78300

Vehicles with a manual transmission

Note: If the clutch pedal is not depressed, a message appears in the information display.

Depress the clutch pedal.

Vehicles with an automatic transmission

Note: If the brake pedal is not depressed, a message appears in the information display.

Depress the brake pedal.

All vehicles

Push the ignition switch in and turn it to switch on the ignition and to start the engine.

Once the system recognizes a passive key, the engine can be started. If no passive key is detected, **PASSIVE KEY NOT DETECTED** will appear in the information display.

Starting the engine with a spare key

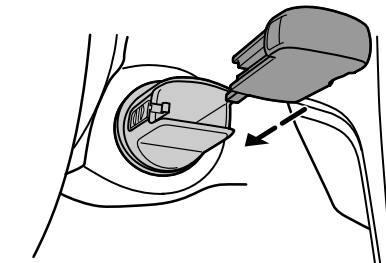

E78301

Assemble the spare key. See **Keyless entry** (page 45).

Insert the spare key into the ignition switch.

Push the ignition switch in and turn it to switch on the ignition and to start the engine.

STARTING A DIESEL ENGINE

Cold/hot engine

Depress the clutch pedal without touching the accelerator.



Turn the key to position **II** and ensure the glow plug indicator lamp illuminates.

Starting the engine

Wait until the lamp extinguishes before starting and continue cranking without pausing until the engine starts.

If the engine stalls, repeat the full starting procedure.

At temperatures below -15°C it may be necessary to operate the starter for up to 30 seconds. If these weather conditions persist, an engine block heater is recommended.

Vehicles with the key free system

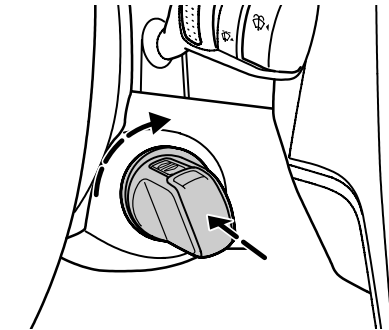

E78300

Vehicles with a manual transmission

Note: If the clutch pedal is not depressed, a message appears in the information display.

Depress the clutch pedal.

Vehicles with an automatic transmission

Note: If the brake pedal is not depressed, a message appears in the information display.

Depress the brake pedal.

All vehicles

Push the ignition switch in and turn it to switch on the ignition and to start the engine.

Once the system recognizes a passive key, the engine can be started. If no passive key is detected, **PASSIVE KEY NOT DETECTED** will appear in the information display.

Starting the engine with a spare key

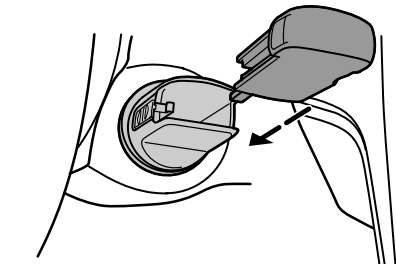

E78301

Assemble the spare key. See **Keyless entry** (page 45).

Insert the spare key into the ignition switch.

Push the ignition switch in and turn it to switch on the ignition and to start the engine.

Starting the engine

DIESEL PARTICULATE FILTER (DPF)

Note: Under certain conditions it is possible for white smoke to be emitted from the exhaust tailpipe. This is a by-product emitted by the particle filter and should not be considered a concern.

SWITCHING OFF THE ENGINE

Vehicles with a diesel engine

CAUTION

 Do not switch the engine off when it is running at high speed. If you do, the turbocharger will continue running after the engine oil pressure has dropped to zero. This will lead to premature turbocharger bearing wear.

Release the accelerator pedal. Wait until the engine has reached idle speed and then switch it off.

Fuel and refuelling

SAFETY PRECAUTIONS

WARNINGS



To avoid fuel spillage that could be hazardous to other road users, always stop refuelling after the fuel nozzle stops the second time. Additional fuel will fill the expansion space in the fuel tank which could lead to fuel overflowing.



The fuel system is under pressure. There is a risk of injury if the fuel system is leaking. Do not use any kind of flames or heat near the fuel system.

FUEL QUALITY

Use only high quality fuel without any supplemental additives or other engine treatments.

Vehicles with a petrol engine

Use **unleaded** petrol according to specification EN 228 or equivalent with **minimum 95 octane**. Leaded fuel or fuel/additives containing other metallic compounds (e.g. manganese-based) may damage the emission system.

Vehicles with a Flexfuel engine

WARNING



Do not modify the fuel system configuration or the components in the system. Do not replace the fuel system or the components with parts not specially designed to be used with bio ethanol. Ford has specially designed materials, components and systems for ethanol-fuelled vehicles, with precisely calibrated systems for efficient operation. The use of other components and materials can create an untested configuration which could result in fire, personal injury or engine damage.

Your Flexifuel vehicle can be operated on **unleaded** petrol according to specification EN 228 or equivalent with **minimum 95** octane or **bio ethanol E 85**. It can also be operated on any mixture of the two. Methanol must **not** be used instead of bio ethanol E 85. The correct fuel type for your vehicle is shown on a decal on the inside of the fuel filler flap.

The vehicle will operate well on commercial quality 95 octane unleaded petrol, but only high quality bio ethanol E 85 offers the same protection and performance.

Fuel and refuelling

Long-term storage

Due to small amounts of corrosive impurities that may be found in the bio ethanol E 85, it is recommended that you fill the tank with only 95 octane unleaded petrol prior to long-term storage of your Flexifuel vehicle.

Vehicles with a diesel engine

Use diesel fuel according to specification EN 590 or equivalent. Do not mix it with any oil, petrol or other liquids. Diesel fuels which contain a mix of up to 5 % RME (bio diesel) are acceptable.

Prolonged use of supplemental additives to prevent fuel waxing is not recommended. Do not add kerosene, paraffin or petrol to diesel fuels.

CATALYTIC CONVERTER

Driving with a catalytic converter

CAUTIONS

- ⚠ Avoid running out of fuel.
- ⚠ Do not crank the engine for long periods.
- ⚠ Do not run the engine when a spark plug lead is disconnected.
- ⚠ Do not push-start or tow-start your vehicle. Use booster cables. See **Using booster cables** (page 228).

- ⚠ Do not switch the ignition off when driving.

Parking

WARNING

- ⚠ Do not park your vehicle over dry leaves or dry grass. The exhaust will continue to radiate a considerable amount of heat after you have switched the engine off. This is a potential fire hazard.

FUEL FILLER FLAP

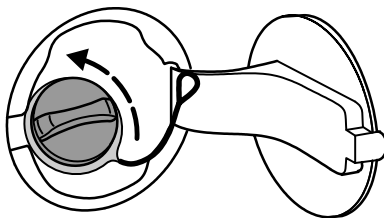

E78089

Open the flap fully until it engages. Turn the fuel filler cap anticlockwise.

When the filler cap is removed, a hissing noise may be heard. This is normal and should be disregarded.

To close, turn the cap clockwise until it clicks.

Fuel and refuelling

REFUELLING

CAUTION

 Do not attempt to start the engine if you have filled the fuel tank with the incorrect fuel. This could damage the engine.

TECHNICAL SPECIFICATIONS

Fuel consumption figures

Variant	Urban	Extra-urban	Combined	CO2 emissions
	l/100 km (mpg)	l/100 km (mpg)	l/100 km (mpg)	g/km
1.4 I Duratec, Stage III and IV, 3-door, 4-door, 5-door and Estate, Axle ratio: 4.06	8.7 (32.5)	5.4 (52.3)	6.6 (42.8)	157
1.6 I Duratec, Stage III and IV, 3-door, 4-door, 5-door and Estate, manual transmission, Axle ratio: 4.06	8.7 (32.5)	5.5 (51.4)	6.7 (42.2)	159
1.6 I Duratec, Stage IV, 3-door, Automatic transmission, Axle ratio: 4.20	10.4 (27.2)	5.9 (47.9)	7.5 (37.7)	180
1.6 I Duratec, Stage IV, 4-door, 5-door and Estate, Automatic transmission, Axle ratio: 4.20	10.6 (26.6)	6.0 (47.1)	7.7 (36.7)	184
1.6 I Duratec, Stage IV, convertible, manual transmission, Axle ratio: 4.06	9.4 (30.1)	5.8 (48.7)	7.1 (39.8)	169
1.6 I Duratec Ti-VCT, Stage IV, 3-door, 4-door, 5-door and Estate, Axle ratio: 4.06	8.7 (32.5)	5.4 (52.3)	6.6 (42.8)	157

Fuel and refuelling

Variant	Urban	Extra-urban	Combined	CO2 emissions
	l/100 km (mpg)	l/100 km (mpg)	l/100 km (mpg)	g/km
1.8 I Duratec-HE, Stage IV, 3-door, 4-door, 5-door and Estate, manual transmission, Axle ratio: 4.06 (Flexfuel engine in petrol mode)	9.5 (29.7)	5.6 (50.4)	7.0 (40.4)	167
2.0 I Duratec-HE, Stage III and IV, 3-door, 4-door, 5-door and Estate, manual transmission, Axle ratio: 4.07	9.8 (28.8)	5.4 (52.3)	7.1 (39.8)	169
2.0 I Duratec-HE, Stage IV, 3-door, 4-door, 5-door and Estate, Automatic transmission, Axle ratio: 4.20	11.2 (25.2)	6.1 (46.3)	8.0 (35.3)	189
2.0 I Duratec-HE, Stage IV, convertible, manual transmission, Axle ratio: 4.07	10.6 (26.6)	5.7 (49.6)	7.5 (37.7)	179
2.5 I Duratec-ST, Stage IV, 3-door and 5-door, Axle ratio: 4.00	13.8 (20.5)	6.8 (41.5)	9.3 (30.4)	224
1.6 I Duratorq-TDCi 66 kW (90 PS), Stage IV, 3-door, 4-door, 5-door and Estate, Axle ratio: 3.41	5.9 (47.9)	4.0 (70.6)	4.7 (60.1)	124
1.6 I Duratorq-TDCi 80 kW (109 PS), Stage III and IV with a DPF, 3-door, 4-door, 5-door and Estate, manual transmission, Axle ratio: 3.41	6.2 (45.6)	4.0 (70.6)	4.8 (58.9)	127

Fuel and refuelling

Variant	Urban	Extra-urban	Combined	CO2 emissions
	l/100 km (mpg)	l/100 km (mpg)	l/100 km (mpg)	g/km
1.6 I Duratorq-TDCi 80 kW (109 PS), Stage III, 3-door, 4-door and 5-door, Durashift CVT, Axle ratio: 4.33	6.9 (40.9)	4.7 (60.1)	5.5 (51.4)	144
1.6 I Duratorq-TDCi 80 kW (109 PS), Stage III, Estate, Durashift CVT, Axle ratio: 4.33	7.0 (40.4)	4.8 (58.9)	5.6 (50.4)	149
1.6 I Duratorq-TDCi 80 kW (109 PS), Stage IV with a DPF, 3-door, 4-door and 5-door, Durashift CVT, Axle ratio: 4.33	7.2 (39.2)	4.7 (60.1)	5.6 (50.4)	149
1.6 I Duratorq-TDCi 80 kW (109 PS), Stage IV with a DPF, Estate, Durashift CVT, Axle ratio: 4.33	7.3 (38.7)	4.8 (58.9)	5.7 (49.6)	152
1.8 I Duratorq-TDCi, Stage IV, 3-door and 5-door, Axle ratio: 3.41	6.7 (42.2)	4.3 (65.7)	5.2 (54.3)	137
1.8 I Duratorq-TDCi, Stage IV, 4-door and Estate, Axle ratio: 3.41	6.8 (41.5)	4.4 (64.2)	5.3 (53.3)	139
2.0 I Duratorq-TDCi 98 kW (133 PS), Stage III, 3-door and 5-door, Axle ratio: 4.07 (2.85 in 5th/6th)	7.4 (38.2)	4.4 (64.2)	5.5 (51.4)	145
2.0 I Duratorq-TDCi 98 kW (133 PS), Stage III, 4-door and Estate, Axle ratio: 4.07 (2.85 in 5th/6th)	7.5 (37.7)	4.5 (62.8)	5.6 (50.4)	148

Fuel and refuelling

Variant	Urban	Extra-urban	Combined	CO2 emissions
	l/100 km (mpg)	l/100 km (mpg)	l/100 km (mpg)	g/km
2.0 I Duratorq-TDCi 98 kW (133 PS), Stage IV, 3-door, 4-door, 5-door and Estate, Axle ratio: 4.07 (2.85 in 5th/6th)	7.4 (38.2)	4.6 (61.4)	5.6 (50.4)	148
2.0 I Duratorq-TDCi 100 kW (136 PS), Stage III, 3-door and 5-door, Axle ratio: 4.07 (2.85 in 5th/6th) - Figures quoted are valid after a running-in period of 5 000 km (3 000 miles)	7.4 (38.2)	4.4 (64.2)	5.5 (51.4)	144
2.0 I Duratorq-TDCi 100 kW (136 PS), Stage III, 4-door and Estate, Axle ratio: 4.07 (2.85 in 5th/6th) - Figures quoted are valid after a running-in period of 5 000 km (3 000 miles)	7.5 (37.7)	4.5 (62.8)	5.6 (50.4)	148
2.0 I Duratorq-TDCi 100 kW (136 PS), Stage IV, 3-door and 5-door, Axle ratio: 4.07 (2.85 in 5th/6th) - Figures quoted are valid after a running-in period of 5 000 km (3 000 miles)	7.4 (38.2)	4.6 (61.4)	5.6 (50.4)	148
2.0 I Duratorq-TDCi 100 kW (136 PS), Stage IV, 4-door and Estate, Axle ratio: 4.07 (2.85 in 5th/6th) - Figures quoted are valid after a running-in period of 5 000 km (3 000 miles)	7.4 (38.2)	4.7 (60.1)	5.7 (49.6)	149

Fuel and refuelling

Variant	Urban	Extra-urban	Combined	CO2 emissions
	l/100 km (mpg)	l/100 km (mpg)	l/100 km (mpg)	g/km
2.0 I Duratorq-TDCi 100 kW (136 PS), Stage IV, convertible, Axle ratio: 4.07 (2.85 in 5th/6th) - Figures quoted are valid after a running-in period of 5 000 km (3 000 miles)	7.7 (36.7)	4.9 (57.6)	5.9 (47.9)	156

Transmission

MANUAL TRANSMISSION

WARNINGS

 Engage reverse gear only when the vehicle is stationary.

 Do not apply any undue lateral force to the gear lever when changing from 5th to 4th gear as this could lead to the inadvertent selection of 2nd gear.

To avoid shifting noises when engaging the reverse gear, wait approximately three seconds with the clutch depressed when the vehicle is stationary.

Reverse gear - 5-speed transmission

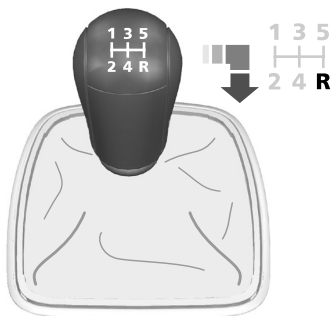

E75050

To select reverse gear, move the gear lever towards the right and rear.

Reverse gear - 6-speed transmission

Except FocusST

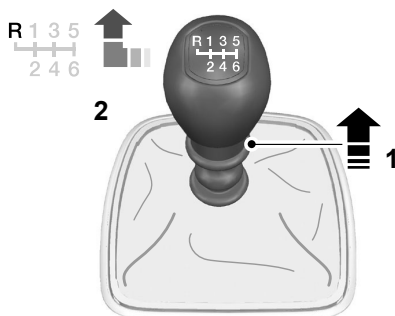

E75052

1. Lift the locking ring.
2. Move the gear lever towards the left and forwards.

FocusST

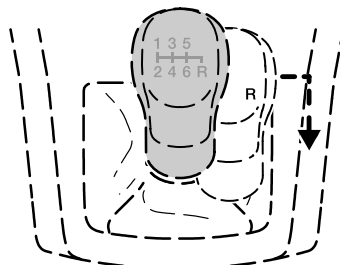

E78829

To select reverse gear, move the gear lever towards the right and rear.

Transmission

AUTOMATIC TRANSMISSION

General information

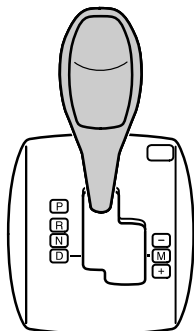

E78310

The Durashift CVT transmission in your vehicle is an electronically controlled transmission. All ratios are continuously variable.

This transmission also allows you to change gear manually (similar to a manual transmission).

The shifting behaviour of the Durashift CVT can be adjusted to suit your personal preferences and driving style. See **Personalised settings** (page 108).

Selector lever

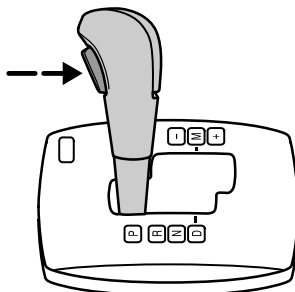

E78311

When moving the selector lever into **P** or **R**, you must first depress the button on the front of the selector lever grip.

When disengaging from **P**, turn the ignition key to position **II** and depress the brake pedal.

Selector lever positions

P = Park

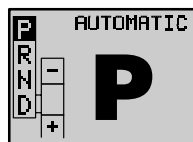

E78312

WARNINGS



This position should be selected only when the vehicle is stationary.

Transmission

 Always apply the parking brake and make sure that the selector lever is securely latched in P. Turn off the ignition whenever you leave the vehicle.

 If position P is not selected, a warning chime will sound when the driver's door is opened.

In this position, the transmission is locked.

The battery saver will deactivate the warning chime after a period of time.

The engine should be started with the selector in position **P**. If necessary, it can also be started with the lever in position **N**.

R = Reverse

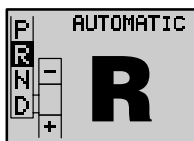

E78313

WARNING

 This position should be selected only when the vehicle is stationary and the engine is idling.

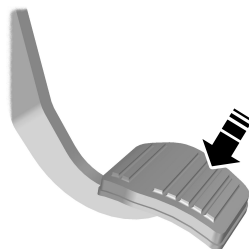

E71354

Depress the brake pedal when selecting **R**.

N = Neutral

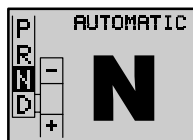

E78314

WARNING

 In this position, you have to depress the brake pedal or apply the parking brake to prevent the vehicle from moving.

In this position no power is transmitted to the drive wheels.

D = Drive

This is the normal driving position.

When the brake pedal is released, the vehicle will creep. All gears/ratios are selected automatically depending on driving conditions.

Transmission

Manual shifting mode

Note: The transmission will perform your manual gear selection when the vehicle road speed and engine speed allow.

Manually selecting gears with the automatic transmission is similar to shifting with a manual transmission. On the 4-speed transmission, there are four forward gears available and on the Durashift CVT transmission, there are seven forward gears available.

This option can be selected at any time. Move the selector lever to **D**, and then guide it to the right.

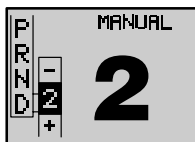
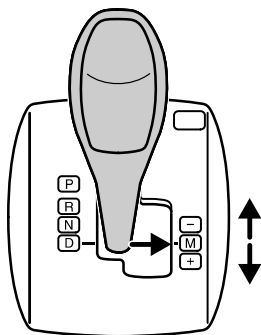

E78316

WARNING



Do not hold the selector lever permanently in - or +.

To shift down, gently push the selector lever forwards (-). To shift up, pull it backwards (+).

Gears can be skipped by moving the selector lever repeatedly at short intervals.

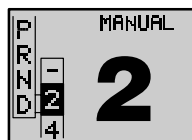

E78317

The requested gear will appear in place of the - or + symbols in the information display, depending on whether a lower or higher gear has been selected. Once the transmission has engaged the requested gear, it will appear in the central position.

Only logical gear selections are possible.

Manual mode also provides a kickdown function. See **Kickdown**.

To avoid engine stall, the transmission will automatically downshift when the vehicle speed is too low.

Transmission

Information messages

ENGAGEMENT IN PROGRESS and **PRESS BRAKE PEDAL**:

At low outside temperatures, after starting the engine it may take the Durashift CVT transmission several seconds to engage **R** (Reverse) or **D** (Drive). In this case, these messages appear alternately in the display until the selected gear has been engaged. If the brake pedal is not held depressed, the transmission will not engage the gear.

Keep the brake pedal depressed until the messages **ENGAGEMENT IN PROGRESS** and **PRESS BRAKE PEDAL** disappear from the display.

TRANSMISSION

MALFUNCTION: Indicates a malfunction of the automatic transmission. Have the transmission checked by an expert immediately.

Driving with automatic transmission

Moving off

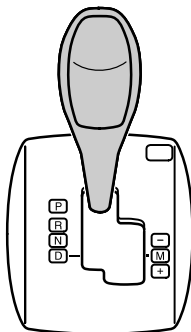

E78310

WARNING



It is not possible to tow-start or push-start a vehicle fitted with an automatic transmission. Use jump leads attached to a booster battery. See **Using booster cables** (page 228).

With the engine idling and the brake pedal depressed, move the selector lever to one of the driving positions. Release the brakes. The vehicle will start to move slowly in the selected direction. Depress the accelerator pedal to increase speed.

Transmission

Moving off in sand, mud and snow

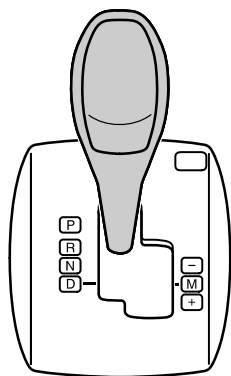

E78318

If the driving wheels are stuck, try to rock the vehicle free by driving forwards and backwards. To do this, move the selector lever alternately to **D** and **R** and depress the accelerator as little as possible.

To increase the effect, move the selector lever to **R** while the vehicle is still moving forward and vice versa.

To avoid excessive wear on the transmission when shifting between forward and reverse (rocking) keep the engine speed as low as possible.

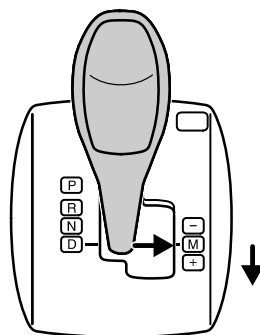

E78319

When the vehicle is stationary, only the manual gears **1** and **2** can be selected.

Kickdown

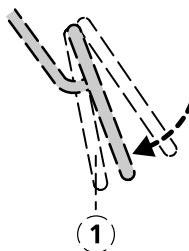

E78320

1 Kickdown

A kickdown function is provided which makes full use of the engine power when overtaking or driving up steep gradients.

When the accelerator pedal is depressed beyond its resistance point, the transmission will down-shift into a lower gear or to the ratio which delivers the maximum acceleration.

Transmission

In position **D**, the Durashift CVT transmission continuously varies the ratios. You will not notice any gearshifts.

In manual shifting mode, the transmission shifts up automatically in steps. In this mode, you will notice the gearshifts.

If the accelerator is not pressed beyond the resistance point, the engine speed will increase to maximum. No kickdown effect will result.

Releasing the accelerator pedal back past the resistance point disengages the kickdown function.

Drive modes

The automatic transmission adapts to support the current driving conditions.

Cold mode

The transmission will display a different shifting behaviour to normal in cold conditions.

Hot mode

When high ambient temperatures and/or loads prevail, the transmission will display a different shifting behaviour to normal. On vehicles with a Durashift CVT transmission, the message **TRANSMISSION MALFUNCTION** will appear in the information display. See **Information messages** (page 121).

Fast off

If you release the accelerator pedal quickly, the transmission maintains the current gear/ratio.

Adaptive sport mode

The transmission recognizes sporty driving and supports this with the appropriate shifting behaviour.

Adaptive shift speed

Durashift CVT only

If you move the accelerator pedal fast, you get fast transmission ratio changes. Slow pedal movements result in slow changes.

Downhill mode

Durashift CVT only

The transmission recognizes downhill driving conditions and supports with increased engine braking.

Uphill mode

Durashift CVT only

The transmission recognizes uphill driving, trailer towing and other high load conditions and supports with increased engine speed to provide more engine power.

Cornering

Durashift CVT only

The transmission recognizes when you drive round a bend and maintains the current ratio.

Transmission

Neutral idle control

Durashift CVT only

Improves comfort and fuel consumption. It is active when the vehicle is standing still with the engine running, the selector in **D** or **R** and the footbrake applied.

Emergency park position release lever

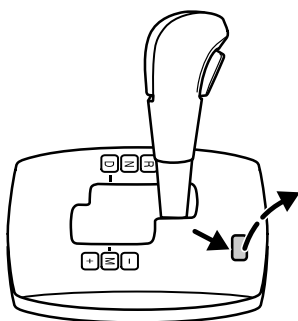

E78321

This enables the selector lever to be moved out of the park position **P** in the event of a discharged battery or electrical failure.

Remove the cover in the centre console next to the selector lever with a small flat bladed tool.

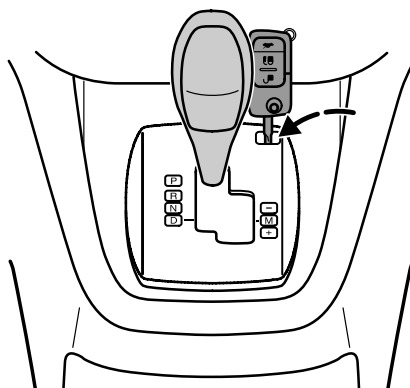

E78322

WARNING

 If position **P** is selected again, this procedure must be repeated.

With a suitable object push down the locking lever in the slot and simultaneously move the selector lever out of the **P** position.

Brakes

PRINCIPLE OF OPERATION

Dual circuit braking system

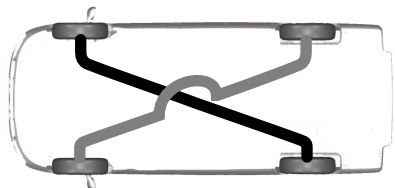

E71353

WARNING

 If a brake circuit fails, you will notice a softer feel to the brake pedal. Press the brake pedal firmly and allow for increased stopping distances. Stop and have this checked immediately. Do not continue your journey.

Your vehicle is fitted with a diagonally split, dual circuit brake system. If a brake circuit fails, the other remains operational.

Disc brakes

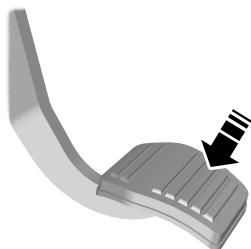

E71354

Wet brake discs result in reduced braking efficiency. Dab the brake pedal when driving from a car wash to remove the film of water.

ABS

WARNING

 The ABS does not relieve you of your responsibility to drive with due care and attention.

The ABS helps you to maintain full steering and directional stability when you brake heavily in an emergency, by preventing the road wheels from locking. The ABS monitors the speed of each road wheel and varies the pressure to each brake. The ABS optimizes the tyre-to-road adhesion when you brake heavily.

HINTS ON DRIVING WITH ABS

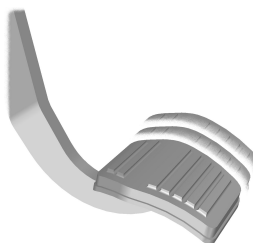

E71355

When the ABS is operating, the brake pedal will pulse. This is normal. Maintain pressure on the brake pedal.

Brakes

The ABS will not eliminate the dangers inherent when:

- you drive too close to the vehicle in front of you.
 - the vehicle is aquaplaning.
 - you take corners too fast.
 - the road surface is poor.
- If your vehicle is parked on a hill and facing uphill, select first gear and turn the steering wheel away from the kerb.
 - If your vehicle is parked on a hill and facing downhill, select reverse gear and turn the steering wheel towards the kerb.

PARKING BRAKE

All vehicles

To release the parking brake, press the brake pedal firmly, pull the lever up slightly, depress the release button and push the lever down.

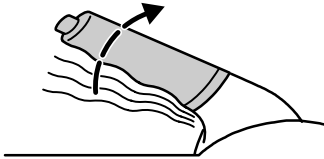

E70430

WARNING



Vehicles with an automatic transmission should always be left with the selector lever in position **P**.

- Press the foot brake pedal firmly.
- Pull the parking brake lever up smartly to its fullest extent.
- Do not press the release button while pulling the lever up.

Stability control

PRINCIPLE OF OPERATION

Electronic stability programme (ESP)

WARNING



ESP does not relieve you of your responsibility to drive with due care and attention.

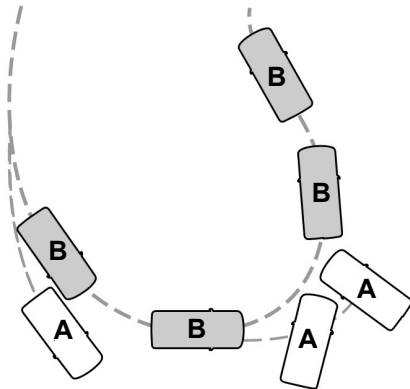

E72903

- A without ESP
- B with ESP

The ESP supports stability when the vehicle starts to slide away from your intended path. This is performed by braking individual wheels and reducing engine torque as needed.

The system also provides an enhanced traction control function by reducing engine torque if the wheels spin when you accelerate. This improves your ability to pull away on slippery roads or loose surfaces, and improves comfort by limiting wheel spin in hairpin bends.

Stability control (ESP) warning lamp

The ESP warning lamp will flash when the system is operating. See **Warning lamps and indicators** (page 98).

Emergency brake assist

WARNING



Emergency brake assist does not relieve you of your responsibility to drive with due care and attention.

Emergency brake assist will detect when you brake heavily by measuring the rate at which you press the brake pedal. It will provide maximum braking efficiency as long as you press the pedal. Emergency brake assist can reduce stopping distances in critical situations.

Stability control

USING STABILITY CONTROL

Switching off ESP

All vehicles

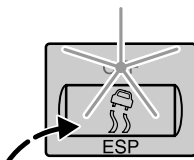

E78085

The system can be switched off manually by pressing and holding the ESP switch **for at least one second**. Both the ESP indicator in the instrument cluster and the **OFF** indicator in the switch will illuminate.

Vehicles with an information display

ESP OFF will appear in the display. The system can be re-enabled by pressing the switch again.

All vehicles

Each time the ignition is switched on, the system is automatically selected.





Parking aid

PRINCIPLE OF OPERATION

WARNING

 The parking aid does not relieve you of your responsibility to drive with due care and attention.

CAUTIONS

-  The sensors may not detect objects in heavy rain or other conditions that cause disruptive reflections.
-  The sensors may not detect objects with surfaces that absorb ultrasonic waves.
-  The sensors may not detect objects that are close to the vehicle (approximately 30 centimetres to the rear and above or below the sensors).
-  If you use a high pressure spray to wash your vehicle, only spray the sensors briefly from a distance not less than 20 centimetres (8 inches).

Note: The parking aid may emit false tones if it detects a signal using the same frequency as the sensors or if the vehicle is fully laden.

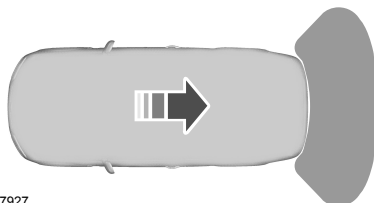

Note: The outer sensors may detect the side walls of a garage. If the distance between the outer sensor and the side wall remains constant for three seconds, the tone will switch off. As you continue, the inner sensors will detect rearward objects.

USING THE PARKING AID



E77927

CAUTIONS

-  Vehicles fitted with a trailer tow module not approved by us may not correctly detect obstacles.
-  Take particular care when reversing with a tow ball arm or rear fitted accessories e.g. a bicycle carrier, as the rear parking aid will only indicate the distance from the bumper to the obstacle.
-  The parking aid does not detect obstacles moving away from the vehicle. They will only be detected shortly after they start to move towards the vehicle again.

Note: The parking aid is deactivated automatically when any trailer lamps or lighting boards are connected to the 13-pin socket using a Ford approved trailer tow module.

Note: Keep the sensors free from dirt, ice and snow. Do not clean with sharp objects.

The parking aid is automatically activated when you select reverse gear with the ignition switched on.

Parking aid

You will hear an intermittent tone at a distance of up to 180 centimetres between the obstacle and rear bumper and 60 centimetres to the side. Decreasing the distance accelerates the intermittent tone. A continuous tone will start at a distance of less than 30 centimetres.

Note: If a high pitch tone is heard for three seconds, this indicates a malfunction. The system will switch off automatically if it malfunctions. Have this checked as soon as possible.

Convertible only

CAUTION

 Do not open the convertible top in confined spaces. This could cause damage to the luggage compartment lid. See **Opening the convertible top** (page 190).

You will hear a continuous warning tone when you operate the convertible roof if an object is detected less than 30 centimetres from the rear bumper.

Cruise control

PRINCIPLE OF OPERATION

WARNING

 Don not use cruise control in heavy traffic, on twisty roads or when the road surface is slippery.

The cruise control system automatically adjusts the power output of the engine to maintain the stored speed. When travelling downhill, vehicle speed may increase above the stored speed as the system does not apply the brakes. In this case, changing down a gear and then pressing the **RES** button may assist the system in returning the vehicle to the stored speed.

The system will not function until the vehicle speed is above 40 km/h (25 mph).

USING CRUISE CONTROL

Switching cruise control on

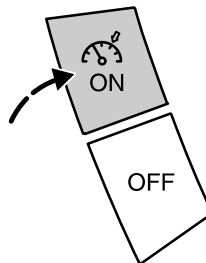

E78050

ON The system is ready to store a speed.

Storing the vehicle speed

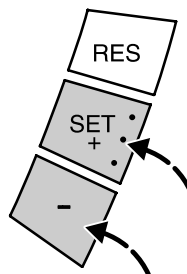

E78051

Press **SET+** or **-**. cruise control system will maintain the vehicle at the current speed.

The indicator in the instrument cluster will illuminate.

Cruise control

Changing the stored vehicle speed

Press **SET+** to accelerate. Press the **-** to decelerate. Vehicle speed will change without the need to depress the accelerator pedal.

The speed at which the switch is released becomes the new stored speed.

The vehicle's speed can also be changed in small steps by momentarily depressing the appropriate switch.

Depressing the accelerator will accelerate the vehicle, without changing the stored speed.

Cancel and resume

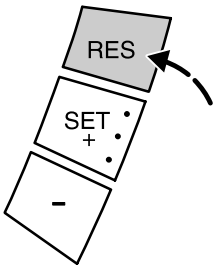

E78052

To cancel, depress the brake or clutch pedal, or press the **RES** switch. The indicator light in the cluster will extinguish.

Press the **RES** switch to resume cruise control at this last stored speed setting.

Switching cruise control off

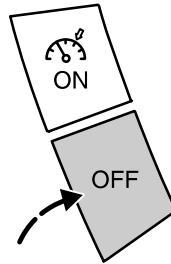

E78053

Any stored speed will be erased. The indicator in the cluster will extinguish.

Automatic speed limiter (ASL)

PRINCIPLE OF OPERATION

Engine speed limiter

The engine speed is limited electronically to protect the engine.

Load carrying

LUGGAGE COVERS

WARNING

 Do not place objects on the luggage cover.

3-door and 5-door

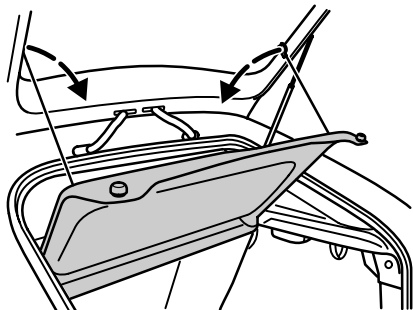

E78832

To remove, detach the two lifting straps on the tailgate. Release the cover at its sides and pull it out horizontally.

To refit, insert the cover horizontally, align it and push in as far as it will go. Attach the lifting straps to the tailgate.

Estate

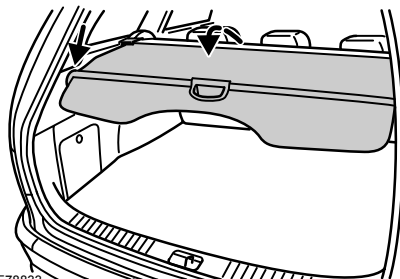

E78833

Pull out the roller cover and secure it in the retaining points.

The cover can be removed completely by pushing the support to the left and lifting out the right-hand side.

REAR UNDER FLOOR STORAGE

3-door and 5-door with full-size spare wheel

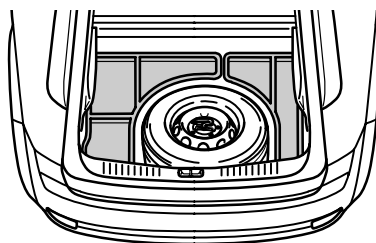

E78846

To gain access to the storage areas, raise the carpet.

Load carrying

CARGO NETS

Cargo retention net

To install the cargo retention net cassette:

Remove the luggage cover.

Push the sliders on the cassette towards each other and insert the telescopic bar into the holes on the sidewall behind the rear seatbacks.

Ensure that the end caps with the anti-rotation pin are correctly fitted in the side trim.

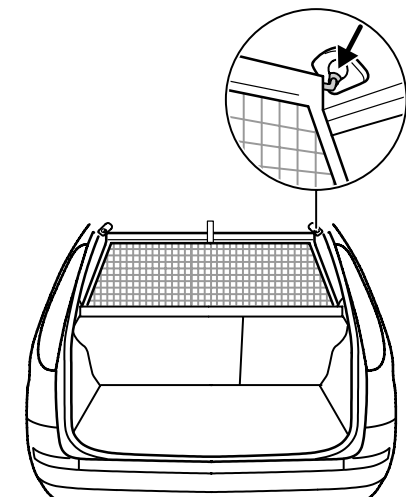

Pull up the net and insert the ends of the bar into the retainers on the roof.

Ensure that the bar is pushed forwards into the narrow section of the retainers.

WARNING

 After installing the cassette, press the front edge of the luggage cover back down into its original position (forwards) to prevent vision out of the rear screen being obscured.

Reinstall the luggage cover.

Remove in the reverse order.

Cargo net

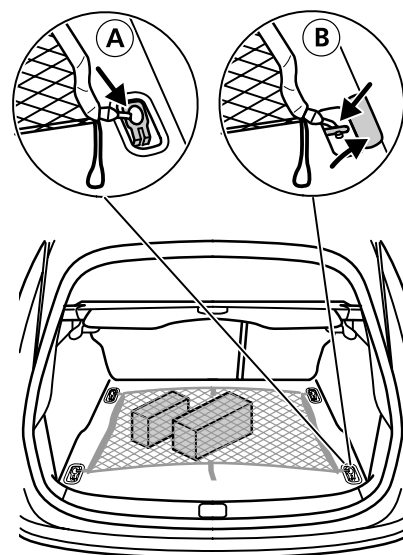

- A With retaining rings
- B Without retaining rings

The cargo net can be used to prevent objects sliding around.

Load carrying

Attach the hooks at each corner of the net to the four retaining points on the load floor.

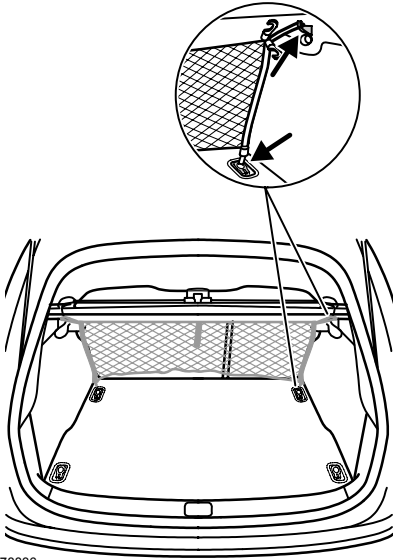

E78836

Note: Access to the net is possible from the rear seats by folding back the front of the luggage cover.

The net can also be hung on the sidewalls. Fold the net in half and press together the Velcro strips on the sides of the net. Attach the loops at the top of the net to the hooks on the sidewall and the hooks at the bottom to the retaining points on the floor.

ROOF RACKS AND LOAD CARRIERS

Estate

WARNINGS

 Distribute the load evenly over the loading area and keep the centre of gravity as low as possible. Secure the load well to prevent it from slipping. Never place any loads directly onto the roof surface.

 After driving for a short distance (50 km/30 miles) and at regular intervals thereafter (approx. 1 000 km/600 miles), depending on the quality of the road, re-tighten the screws to the specified torque (5 Nm) and check that the load is positioned properly and well secured.

 Remove the crossbars when not in use as any roof load will increase fuel consumption.

 Remove the crossbars before entering an automatic car wash.

The side mounting tracks are designed such that crossbars (for bicycle carriers, ski carriers etc.) from the Ford accessories range can be fitted.

The maximum permissible roof load is 75 kg, including the crossbars (4 kg).

Load carrying

Installing the crossbars

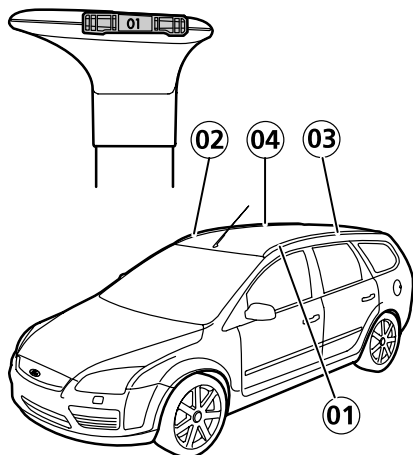

E78847

Before installing the crossbars, clean the side mounting tracks with water and a sponge.

The feet of the crossbars are numbered. Ensure that they are installed in the positions shown.

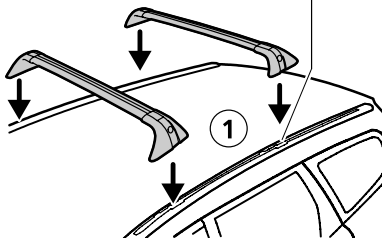
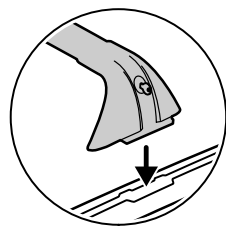

E78848

Insert the crossbars into the tracks **1**.

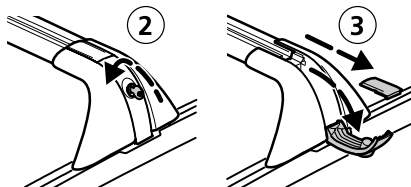

E78849

Turn the key anticlockwise to unlock **2**. Release the lever **3** and remove the cover to gain access to the screw.

Load carrying

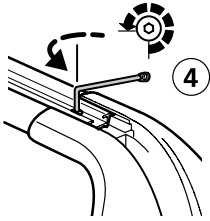

E78850

Loosen the screw **4**. The crossbars can now be slid along the tracks.

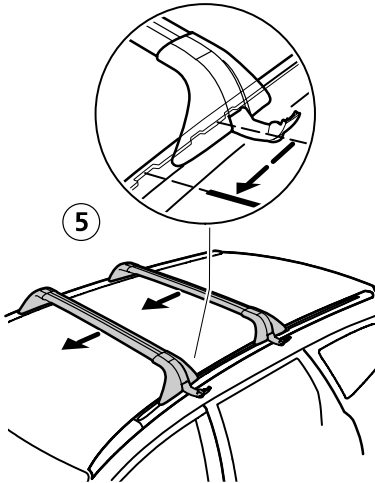

E78851

Slide the crossbars forwards into position **5**.

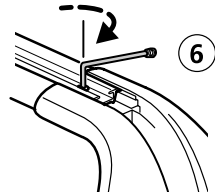

E78852

Tighten the screw **6** (torque of 5 Nm).

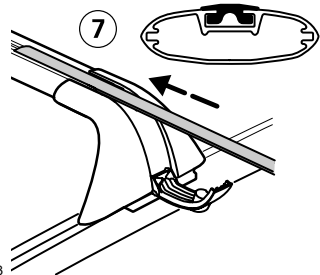

E78853

Insert the strip **7**.

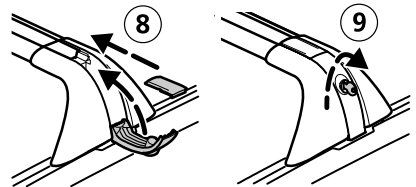

E78854

Insert the screw cover and close the lever **8**. Lock the crossbar in position by turning the key clockwise **9**. Remove the key from the crossbar.

Towing

TOWING A TRAILER

WARNING

 Do not exceed the maximum vehicle and trailer weight stated on the vehicle identification plate.

Place loads as low and central to the axle(s) of the trailer as possible. If you are towing with an unladen vehicle, the load in the trailer should be placed toward the nose, within the maximum nose load, as this gives the best stability.

The stability of the vehicle to trailer combination is very much dependant on the quality of the trailer.

Above 1 000 metres in high altitude regions, the stipulated maximum permitted gross train mass must be reduced by 10% for every 1 000 metres.

Steep gradients

WARNING

 The overrun brake on a trailer is not controlled by the anti-lock braking system.

Change down a gear before you reach a steep downhill gradient.

DETACHABLE TOW BALL

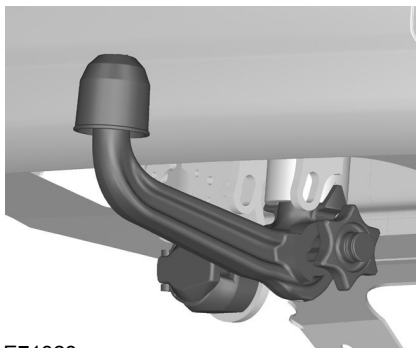

E71328

WARNING

 The tow ball arm must be stored securely in the luggage compartment at all times when detached.

Unlocking the tow ball arm mechanism

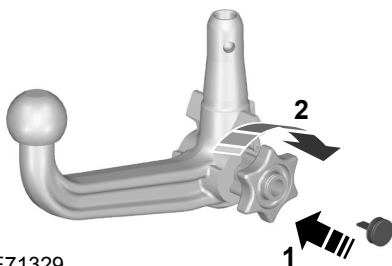

E71329

Towing

WARNING

 Do not use any tools for mounting or dismounting the tow ball arm. Do not modify the trailer coupling. Do not disassemble or repair the tow ball arm.

1. Remove the protecting cap. Insert the key and turn anticlockwise to unlock.
2. Pull the handwheel out and turn it clockwise until it clicks.

The red mark on the handwheel must align with the white mark on the tow ball.

Release the handwheel. The tow ball arm is unlocked.

Inserting the tow ball arm

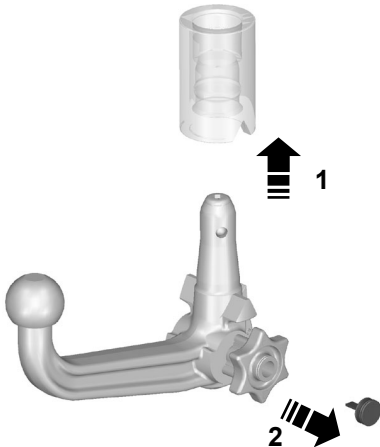

E71330

WARNINGS

 Special care should be taken when fitting the tow ball arm, as the safety of the vehicle and the trailer depends on this.

 The tow ball arm may only be inserted when completely unlocked.

Pull out the plug of the tow ball arm's seat.

Note: When the towball arm is engaged, the green mark on the handwheel will be next to the white dot.

1. Insert the tow ball arm vertically and press it upwards until it engages. Do not hold your hand near the handwheel.
2. To lock: Turn the key clockwise and remove the key.

Insert the end of the protection cap into the keyhole.

Driving with a trailer

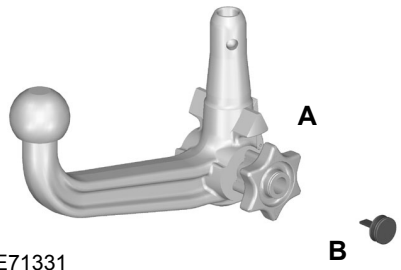

E71331

Towing

WARNING

 If any of the below conditions cannot be met, do not use the tow bar and have it inspected by an expert.

Before starting your journey, ensure the tow ball arm is properly locked. Check that:

- The green mark on the handwheel is next to the white dot on the tow ball arm.
- The handwheel **A** is pushed in against the tow ball arm.
- The key **B** has been removed.
- Secure positioning of the towball arm. (Must remain perfectly in place when jerked.)

Removing the tow ball arm

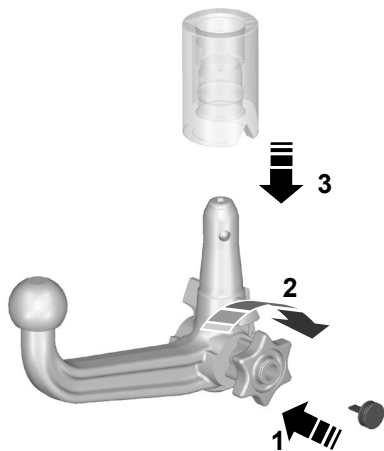

E71332

1. Remove the protection cap covering the keyhole. Insert the key and turn it anticlockwise to unlock.
2. Hold the towball arm. Pull out the handwheel and turn it clockwise until it clicks and pull the towball arm downwards.
3. Remove the tow ball arm.

Release the handwheel.

When unlocked in this way, the tow ball arm can be reinserted at any time.

Insert the plug into its seat.

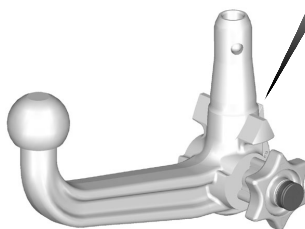
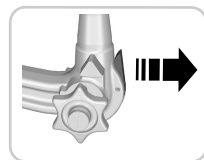

E71333

WARNING

 To avoid risk of injury, never unlock the towball arm with the trailer attached.

Towing

If not in use for longer periods of time, lock the mechanism. Push the lever forwards.

Maintenance

WARNING



Remove the tow ball arm and protect the seat with the plug before steam cleaning your vehicle.

Keep the system clean. Periodically lubricate the lock with graphite.

Keep a note of the key number.

Convertible top

OPENING THE CONVERTIBLE TOP

Convertible top operating clearance

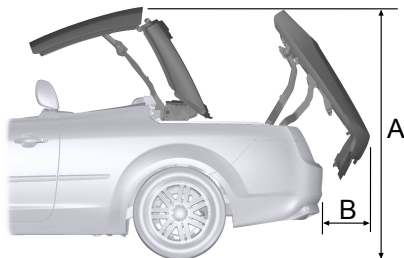

E77958

- A 2050 millimetres (80.7 inches)
- B 190 millimetres (7.5 inches)

WARNINGS

 Make sure that there are no obstructions in the convertible top linkage area, windscreen frame, door windows and rear quarter windows before opening or closing the convertible top.

 Keep the areas around the rollover bar covers free from obstruction.

CAUTIONS

 Do not operate the convertible top when the temperature is below -5°C .

 Make sure that the luggage separator is correctly located in the deployed position.

 Do not operate the convertible top if the vehicle is moving. This could damage the convertible top.

 Do not **OPEN** the convertible top manually. This could damage the linkage mechanism.

Note: The convertible top will lock and unlock automatically.

Note: The front windows and rear quarter windows will open automatically.



E77959

1. Move the luggage separator to the fully deployed position.
2. Switch the ignition to position II.
3. Press and hold the convertible top switch until the convertible top is fully open.

Luggage separator

CAUTIONS

 Do not place luggage items on top of the luggage separator. This could damage the luggage separator or convertible top.

Convertible top

 Do not place large objects underneath the luggage separator. This could damage the convertible top.

Note: The luggage separator prevents items from moving into the area in which the convertible top is stowed.

Note: The convertible top will not open until the luggage separator is in the fully deployed position.

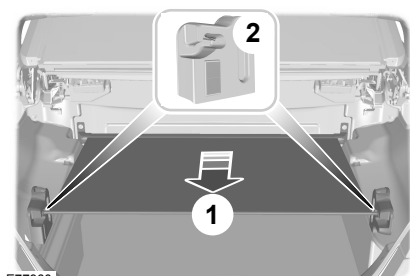

E77960

1. Pull the luggage separator.
2. Slide the locating lugs into the sliders on either side of the luggage compartment to close the proximity switch.

Wind deflector

WARNING

 Do not allow passenger's to travel in the rear of the vehicle with the wind deflector installed.

Note: Use the zips in the wind deflector to store and retrieve luggage from the rear seat.

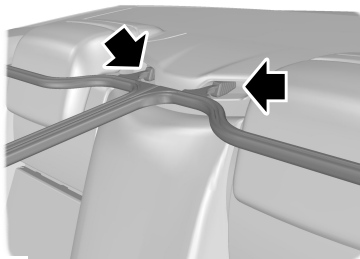

E78180

- Unfold the wind deflector and lock the catch.
- Fit the supports into the rear seat belt openings.

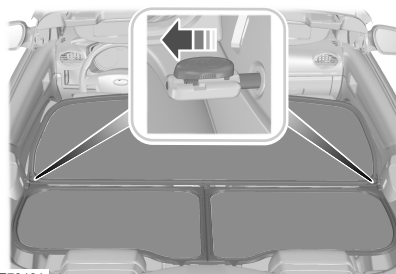

E78181

Engage the levers in the catch.

CLOSING THE CONVERTIBLE TOP

Note: The front windows and rear quarter windows will close automatically.

1. Switch the ignition to position **II**.
2. Press and hold the convertible top switch until the convertible top is fully closed.

Convertible top

Manual closure of the convertible top

WARNINGS



The luggage compartment lid and convertible top are heavy. You will need assistance closing the convertible top.



Do not drive with the luggage compartment lid locking levers unlocked.

Convertible top

1. Open the luggage compartment lid.



E78025

2. Remove the convertible top locking lever trim panel.

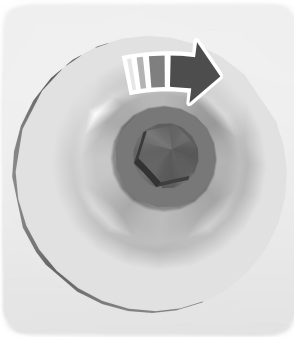

E78026

3. Use the Allen key and unlock the convertible top locking lever.



E78027

4. Remove the luggage compartment carpet retaining clips and pull the carpet away slightly.

Convertible top

5. Pull the luggage compartment lid locking lever release cable on both sides.

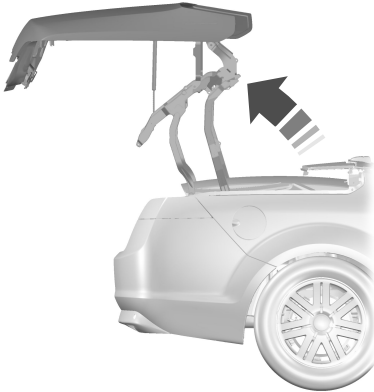

E78029

Note: The tonneau cover will raise with the convertible top.

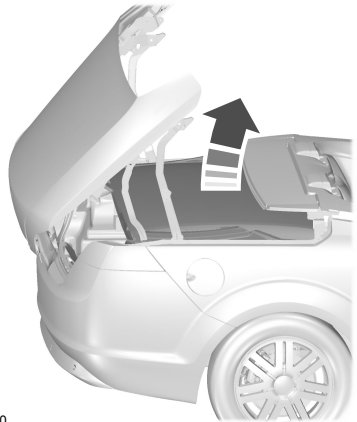

E78030

6. Raise the luggage compartment lid.

7. Close the convertible top.



E78031

8. Lock the convertible top locking lever.

Convertible top

9. Install the convertible top locking lever trim panel.
10. Lower the luggage compartment lid.
11. Open the luggage compartment lid from the rear.

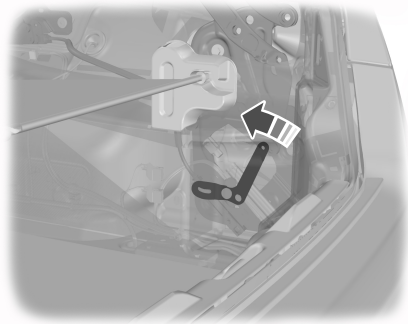

E78028

12. Lock the luggage compartment lid locking levers.
13. Install the luggage compartment trim and retaining clips.
14. Close the luggage compartment lid.

Driving hints

RUNNING-IN

Tyres

WARNING



New tyres need to be run-in for approximately 500 kilometres (300 miles). During this time, you may experience different driving characteristics.

Brakes

WARNING



Avoid heavy use of the brakes if possible for the first 150 kilometres (100 miles) in town and for the first 1 500 kilometres (1 000 miles) on motorways.

Engine

CAUTION



Avoid driving too fast during the first 1 500 kilometres (1 000 miles). Vary your speed frequently and change up through the gears early. Do not labour the engine.

Emergency equipment

FIRST AID KIT

3-door and 5-door

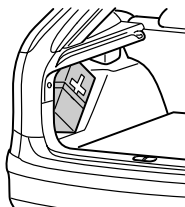

E78856

4-door

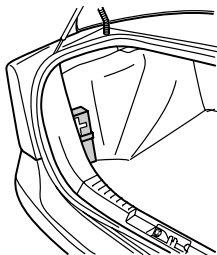

E78857

Estate

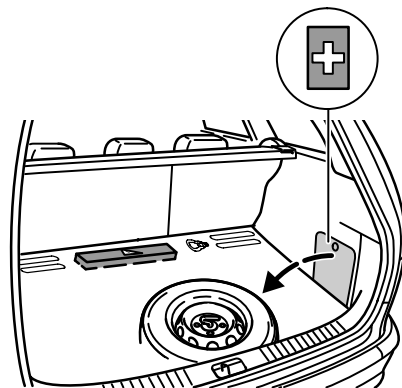

E78858

WARNING TRIANGLE

3-door and 5-door

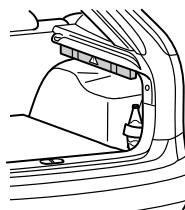

E78859

Emergency equipment

4-door

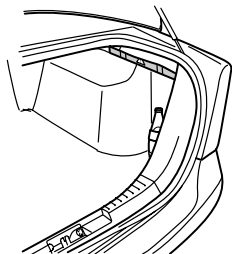

E78860

Estate

A storage area for a warning triangle is located under the carpet.

Status after a collision

FUEL CUT-OFF SWITCH

Vehicles with a Duratec engine

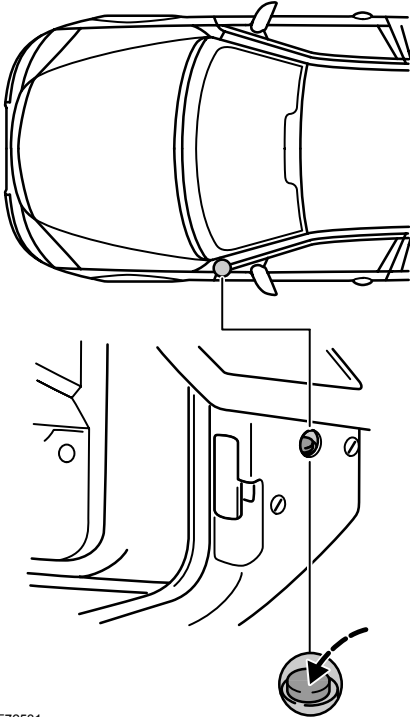

E72531

The fuel supply may be cut off as a result of an accident or sudden vibrations (e.g. collision when parking).

The switch is located in the side panel in front of the left-hand door. The button will be raised when the switch is activated.

Resetting the switch

WARNING



Do not reset the fuel cut-off switch if you see or smell leaking fuel.

- Turn the ignition switch to position **0**.
- Check fuel system for leaks.
- If no fuel leak is apparent, reset the switch by pushing in the button (see illustration).
- Turn the ignition switch to position **II**. After a few seconds return the key to position **I**.
- Make a further check for leaks in the fuel system.

INSPECTING SAFETY SYSTEM COMPONENTS

Seat belts

Belts subjected to strain – as a result of an accident – should be renewed and the anchorages checked by an expert.

Fuses

FUSE BOX LOCATIONS

WARNING

 Any improper alterations to the electrical or fuel system can endanger the safety of the vehicle as they could constitute a fire hazard or cause engine damage. Have any work involving these systems or the replacement of relays or high current carrying fuses carried out by an expert.

Left-hand drive

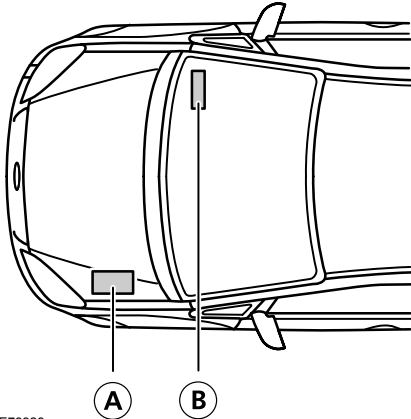

- A Auxiliary fuse box
- B Central fuse box

Right-hand drive

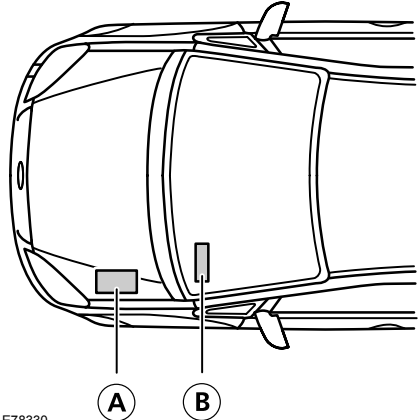

- A Auxiliary fuse box
- B Central fuse box

Auxiliary fuse box

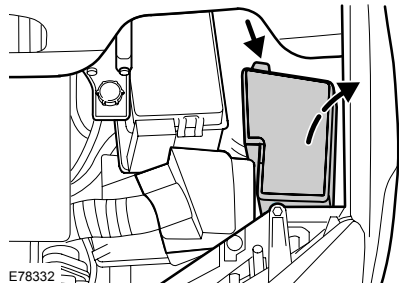

This is located on the left-hand side of the engine compartment.

To open, pull up the lever at the rear of the fuse box and lift off the lid.

Fuses

Central fuse box

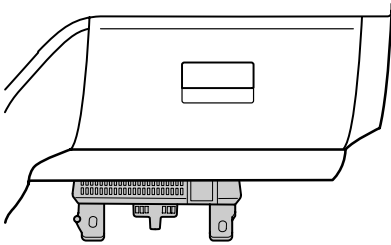

E78331

This is located behind the glove compartment in the instrument panel.

To gain access to the fuse box:

- Remove the screws in the instrument panel trim underneath the glove compartment and let the trim panel drop down.
- Loosen the quick fix screws on the fuse box.

- Let the fuse box down and pull it towards you.
- Hang the fuse box in the front fixture of the bracket.

Reinstall in the reverse order.

CHANGING A FUSE

WARNING



Switch off the ignition and all the electrical equipment before changing a fuse.

Always replace a faulty fuse with a new one of the same rating.

A fuse puller is located in the lid of the auxiliary fuse box.

Fuses

FUSE SPECIFICATION CHART

Engine junction box

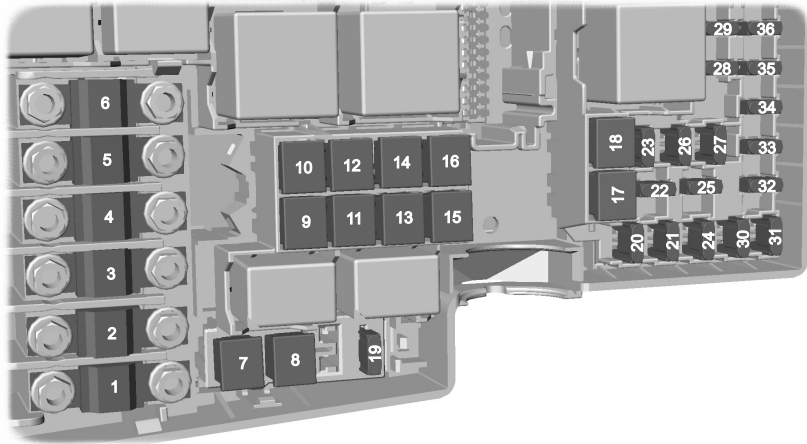

E79716

Fuses

Fuse	Ampere rating	Circuits protected
1	50	Cooling fan
2	80	Power steering
3	60	Passenger junction box supply 1
4	60	Passenger junction box supply 2
5	80	Climate control
6	60	Auxiliary heater (diesel only)
7	30	ABS, stability control pump
8	20	ABS, stability control valves
9	20	Powertrain control module (all except FocusST)
9	30	Powertrain control module (FocusST only)
10	30	Climate control blower
11	20	Ignition switch
12	40	Ignition relay 15l
13	20	Starter solenoid
14	40	Heated windscreen, right-hand side
15	30	Cooling fan relay
16	40	Heated windscreen, left-hand side
17	30	Electric parking brake (all except convertible)
17	30	Roof control module (convertible only)
18	-	Not used
19	10	ABS module
20	15	Horn
21	20	Auxiliary heater
22	10	Power steering module
23	30	Headlamp washer
24	15	Auxiliary heater (diesel only)
25	10	Ignition, relays
26	10	Automatic transmission
27	10	Air conditioning clutch
28	10	Glow plug monitoring (diesel only)
29	10	Dual zone climate control
30	3	Powertrain control module, automatic transmission
31	10	Battery sensor smart charging

Fuses

Fuse	Ampere rating	Circuits protected
32	10	Automatic transmission
32	10	Fuel injector power supply (FocusST only)
33	10	Heated oxygen sensors (petrol only)
33	10	Intercooler bypass valve (diesel only)
33	20	Heated oxygen sensor (FocusST only)
34	10	Injectors, ignition transformers
35	10	Powertrain control module, valves, solenoids (all except FocusST)
35	15	Powertrain control module, valves, solenoids, crank heater element (FocusST only)
36	10	Powertrain control module

Passenger junction box

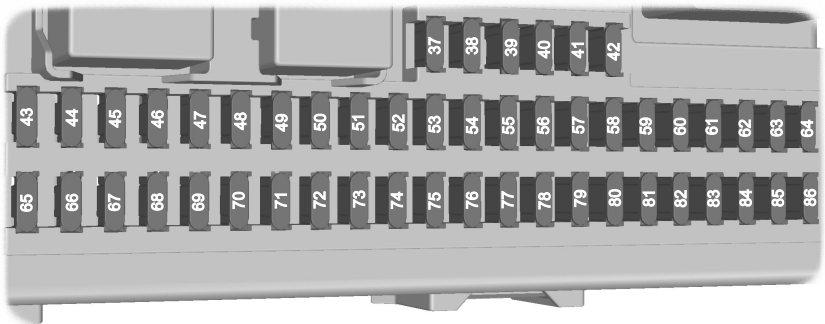

E78360

Fuses

Fuse	Ampere rating	Circuits protected
37	10	Main beam left-hand side
38	10	Main beam right-hand side
39	20	Cigar lighter, rear auxiliary power socket
40	20	Electric sunroof control module
41	20	Front passenger door module
42	7.5	Heated exterior mirrors
43	10	Heater control, steering column, DPF, remote control receiver, DVD player, alarm
44	10	Not used
45	10	Daytime running lamps (parking lamps)
46	10	Instrument cluster battery supply, on-board diagnostics
47	15	Washer pump, heated washer jets
48	20	Daytime running lamps
49	10	Lighting control battery supply
50	20	Windscreen wipers
51	15	Fuel pump
52	25	Heated rear window
53	7.5	Parking lamps, side lamps, tail lamps (left-hand side)
54	7.5	Parking lamps, side lamps, tail lamps (right-hand side)
55	20	Central locking, driver door module
56	20	Key free system
57	10	Battery backup sounder
58	15	Audio modules battery supply
59	25	Trailer tow module, luggage compartment auxiliary power socket
60	15	Dipped beam, right-hand side
61	15	Dipped beam, left-hand side
62	20	Driver's electric seat
63	25	Electric windows
64	20	Not used
65	10	Airbag module
66	7.5	Lighting control ignition supply

Fuses

Fuse	Ampere rating	Circuits protected
67	10	Instrument cluster ignition supply, engine immobiliser
68	7.5	Accessory to cluster (audio and navigation unit)
69	20	Fog lamps
70	10	Electronic modules ignition supply
71	10	Daytime running lamps ignition supply to lighting control switch
72	25	Not used
73	7.5	Number plate lamps
74	15	Brake lamps
75	10	Powertrain control module, accelerator pedal, automatic transmission
76	7.5	Electric parking brake
77	25	Central locking relays
78	15	Rear window wiper
79	15	Electric folding mirror
80	10	Battery saver, interior lamps
81	20	Door module, right-hand rear
82	20	Door module, left-hand rear
83	10	Audio modules (high level)
84	10	Reversing lamp, electric mirrors
85	10	Cooling unit
86	20	Heated front seats

Vehicle recovery

TOWING POINTS

WARNING



The screw-in towing eye has a left-hand thread. Install it by turning anticlockwise. Use the wheelbrace to ensure the towing eye is fully tightened.

The towing eye must always be carried in the vehicle.

3-door, 4-door and 5-door

The screw-in towing eye is attached to the jack.

Vehicles with a tow bar

The towing eye cannot be installed at the rear of the vehicle. Use the towbar to tow a vehicle.

Estate

The screw-in towing eye is located in the storage area under the carpet in the luggage compartment.

All vehicles

Front towing eye

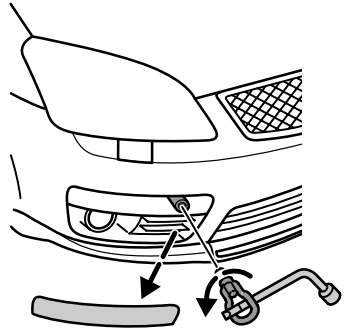

E78367

Insert your finger into the hole on the underside of the cover and prise off the cover. Install the towing eye.

Rear towing eye

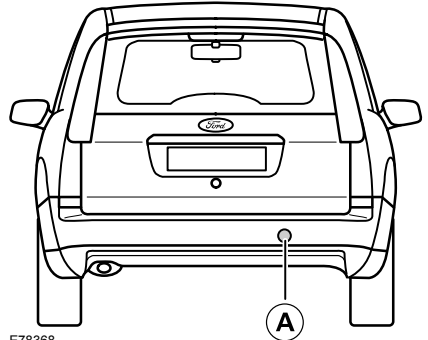

E78368

A Mount for rear towing eye

Vehicle recovery

TOWING THE VEHICLE ON FOUR WHEELS

WARNINGS

 The ignition key must be set to position II when the vehicle is being towed so that the steering, direction indicators and brake lamps are fully operational. Since the brake servo and the power steering do not operate with the engine switched off, you will need to exert greater force to the brake pedal and steering wheel. Make allowances for the increased braking distance and heavier steering.

 To prevent damage you must not push- or tow-start your vehicle. Use booster cables and a booster battery. See **Using booster cables** (page 228).

Note: Observe the safety regulations that are valid for towing a vehicle depending on country.

When towing always drive off slowly and smoothly without jerking the towing vehicle. Excessive tow rope tension could result in damage to either vehicle.

Towing vehicles with automatic transmission

WARNINGS

 Never tow a vehicle with an automatic transmission faster than 50 km/h (30 mph) or further than 50 kilometres (30 miles).

 Never tow a vehicle backwards with the drive wheels turning. If this instruction is not adhered to, it could cause damage to the automatic transmission.

 Push- or tow-starting is not possible on a vehicle fitted with an automatic transmission. Use booster cables. See **Using booster cables** (page 228).

When a vehicle with an automatic transmission is towed, the selector lever must be in position **N** (neutral).

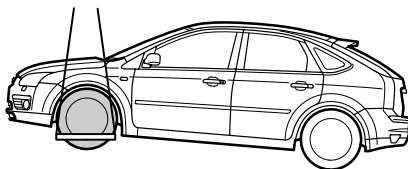

E78886

If it is necessary to tow the vehicle a greater distance, the drive wheels must be lifted clear off the ground.

Towing vehicles with a key free system

When a vehicle with a key free system is towed:

- Insert the spare key into the ignition switch.
- Turn the ignition switch to position **II**.

Maintenance

GENERAL INFORMATION

Have your vehicle serviced regularly to help maintain its roadworthiness and resale value. There is a large network of Ford Authorised Repairers that are there to help you with their professional servicing expertise. We believe that their specially trained technicians are best qualified to service your vehicle properly and expertly. They are supported by a wide range of highly specialised tools developed specifically for servicing your vehicle.

In addition to regular servicing, we recommend that you carry out the following additional checks.

WARNINGS



Switch the ignition off before touching or attempting adjustment of any kind.



Do not touch the electronic ignition system parts after you have switched the ignition on or when the engine is running. The system operates at high voltage.



Keep your hands and clothing clear of the engine cooling fan. Under certain conditions, the fan may continue to run for several minutes after you have switched the engine off.

Daily checks

- Exterior lamps.
- Interior lamps.
- Warning lamps and indicators.

Check when refuelling

- Engine oil level. See **Engine oil check** (page 218).
- Brake fluid level. See **Brake and clutch fluid check** (page 221).
- Washer fluid level. See **Washer fluid check** (page 222).
- Tyre pressures (when cold). See **Technical specifications** (page 241).
- Tyre condition. See **Tyre care** (page 235).

Monthly checks

- Engine coolant level (engine cold). See **Engine coolant check** (page 220).
- Pipes, hoses and reservoirs for leaks.
- Power steering fluid level. See **Power steering fluid check** (page 222).
- Air conditioning operation.
- Parking brake operation.
- Horn operation.

Maintenance

OPENING AND CLOSING THE BONNET

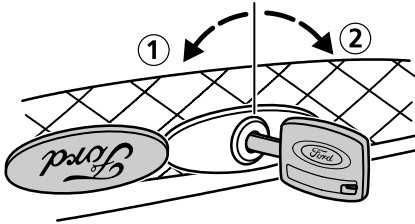

E78141

WARNING



To prevent damage to, or loss of the key, remove the key immediately after opening and swivel the Ford badge back.

Note: On vehicles with the key free system, use the spare key to open the bonnet.

Swivel the Ford badge in the radiator grille to the side and turn the key first anticlockwise **1**. Raise the bonnet slightly and turn the key fully clockwise **2** to open the bonnet.

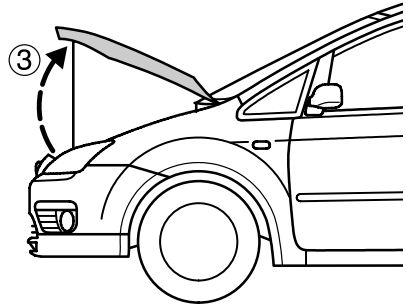

E78142

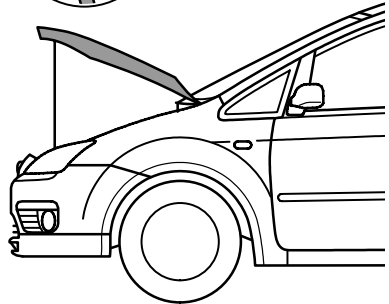
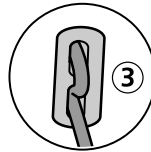

E78143

Raise the bonnet and support it with the end of its strut in the retainer **3** ensuring it is secure.

To close, lower the bonnet and allow it to drop into the catch for the last 20-30 cm.

Always check to ensure that the bonnet lock is fully engaged.

Maintenance

ENGINE COMPARTMENT OVERVIEW

1.4/1.6 I Duratec

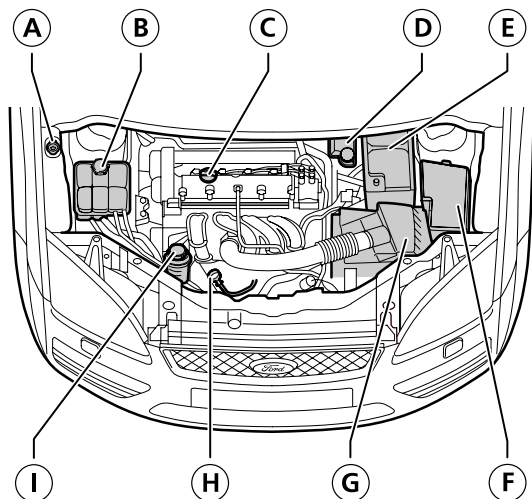

E78887

- A Washer fluid reservoir*. See **Washer fluid check** (page 222).
- B Engine coolant reservoir*. See **Engine coolant check** (page 220).
- C Engine oil filler cap*. See **Engine oil check** (page 218).
- D Brake/clutch fluid reservoir*. See **Brake and clutch fluid check** (page 221).
- E Battery. See **Vehicle battery** (page 228).
- F Auxiliary fuse box. See **Fuses** (page 200).
- G Air cleaner.
- H Engine oil dipstick*. See **Engine oil check** (page 218).
- I Power steering fluid reservoir*. See **Power steering fluid check** (page 222).

* For easy identification, filler caps and the engine oil dipstick are marked in colour.

Maintenance

1.6 I Duratec Ti-VCT

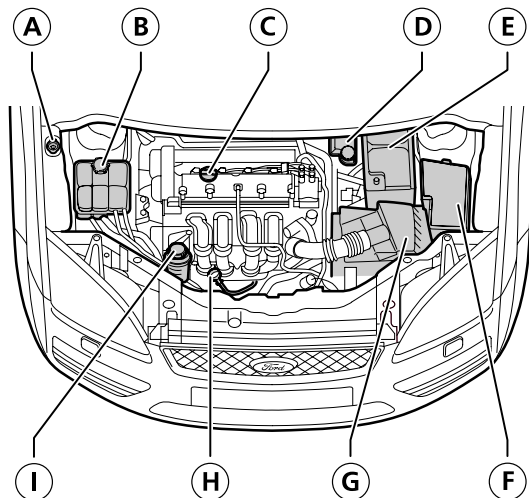

E78888

- A Washer fluid reservoir*. See **Washer fluid check** (page 222).
- B Engine coolant reservoir*. See **Engine coolant check** (page 220).
- C Engine oil filler cap*. See **Engine oil check** (page 218).
- D Brake/clutch fluid reservoir*. See **Brake and clutch fluid check** (page 221).
- E Battery. See **Vehicle battery** (page 228).
- F Auxiliary fuse box. See **Fuses** (page 200).
- G Air cleaner.
- H Engine oil dipstick*. See **Engine oil check** (page 218).
- I Power steering fluid reservoir*. See **Power steering fluid check** (page 222).

* For easy identification, filler caps and the engine oil dipstick are marked in colour.

Maintenance

1.8/2.0 | Duratec-HE

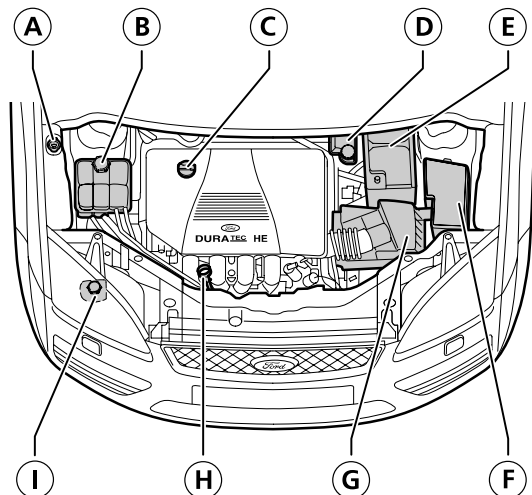

E78889

- A Washer fluid reservoir*. See **Washer fluid check** (page 222).
- B Engine coolant reservoir*. See **Engine coolant check** (page 220).
- C Engine oil filler cap*. See **Engine oil check** (page 218).
- D Brake/clutch fluid reservoir*. See **Brake and clutch fluid check** (page 221).
- E Battery. See **Vehicle battery** (page 228).
- F Auxiliary fuse box. See **Fuses** (page 200).
- G Air cleaner.
- H Engine oil dipstick*. See **Engine oil check** (page 218).
- I Power steering fluid reservoir*. See **Power steering fluid check** (page 222).

* For easy identification, filler caps and the engine oil dipstick are marked in colour.

Maintenance

2.5 I Duratec-ST

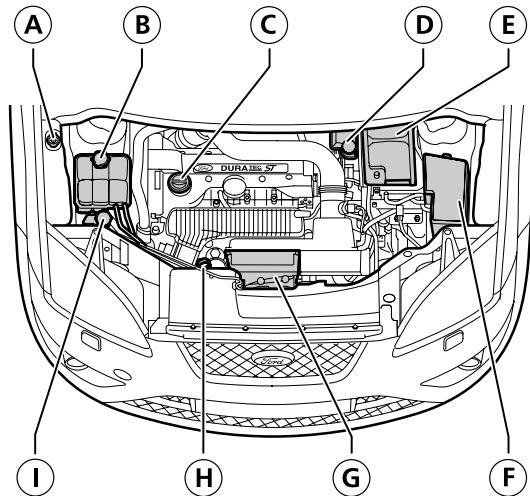

E78890

- A Washer fluid reservoir*. See **Washer fluid check** (page 222).
- B Engine coolant reservoir*. See **Engine coolant check** (page 220).
- C Engine oil filler cap*. See **Engine oil check** (page 218).
- D Brake/clutch fluid reservoir*. See **Brake and clutch fluid check** (page 221).
- E Battery. See **Vehicle battery** (page 228).
- F Auxiliary fuse box. See **Fuses** (page 200).
- G Air cleaner.
- H Engine oil dipstick*. See **Engine oil check** (page 218).
- I Power steering fluid reservoir*. See **Power steering fluid check** (page 222).

* For easy identification, filler caps and the engine oil dipstick are marked in colour.

Maintenance

1.6 I Duratorq-TDCi

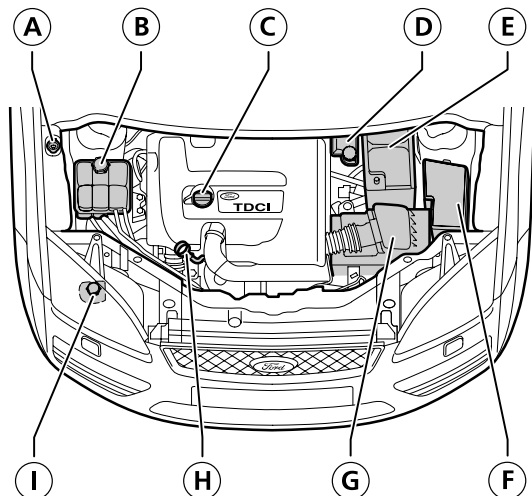

E78891

- A Washer fluid reservoir*. See **Washer fluid check** (page 222).
- B Engine coolant reservoir*. See **Engine coolant check** (page 220).
- C Engine oil filler cap*. See **Engine oil check** (page 218).
- D Brake/clutch fluid reservoir*. See **Brake and clutch fluid check** (page 221).
- E Battery. See **Vehicle battery** (page 228).
- F Auxiliary fuse box. See **Fuses** (page 200).
- G Air cleaner.
- H Engine oil dipstick*. See **Engine oil check** (page 218).
- I Power steering fluid reservoir*. See **Power steering fluid check** (page 222).

* For easy identification, filler caps and the engine oil dipstick are marked in colour.

Maintenance

1.8 | Duratorq-TDCi

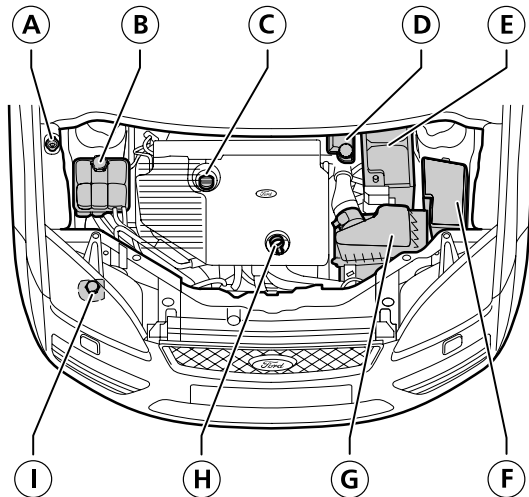

E78892

- A Washer fluid reservoir*. See **Washer fluid check** (page 222).
- B Engine coolant reservoir*. See **Engine coolant check** (page 220).
- C Engine oil filler cap*. See **Engine oil check** (page 218).
- D Brake/clutch fluid reservoir*. See **Brake and clutch fluid check** (page 221).
- E Battery. See **Vehicle battery** (page 228).
- F Auxiliary fuse box. See **Fuses** (page 200).
- G Air cleaner.
- H Engine oil dipstick*. See **Engine oil check** (page 218).
- I Power steering fluid reservoir*. See **Power steering fluid check** (page 222).

* For easy identification, filler caps and the engine oil dipstick are marked in colour.

Maintenance

2.0 I Duratorq-TDCi

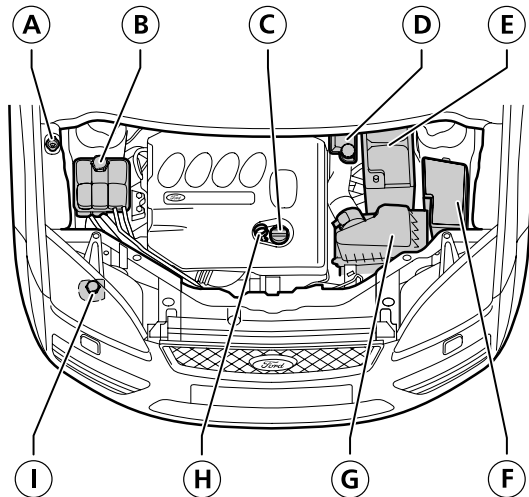

E78893

- A Washer fluid reservoir*. See **Washer fluid check** (page 222).
- B Engine coolant reservoir*. See **Engine coolant check** (page 220).
- C Engine oil filler cap*. See **Engine oil check** (page 218).
- D Brake/clutch fluid reservoir*. See **Brake and clutch fluid check** (page 221).
- E Battery. See **Vehicle battery** (page 228).
- F Auxiliary fuse box. See **Fuses** (page 200).
- G Air cleaner.
- H Engine oil dipstick*. See **Engine oil check** (page 218).
- I Power steering fluid reservoir*. See **Power steering fluid check** (page 222).

* For easy identification, filler caps and the engine oil dipstick are marked in colour.

Maintenance

ENGINE OIL CHECK

WARNING

 Do not use oil additives or other engine treatments. They are unnecessary and could, under certain conditions, lead to engine damage which is not covered by Ford Warranty.

The oil consumption of new engines reaches the normal value only after approximately 5 000 km (3 000 miles).

Make sure the vehicle is standing on level ground. Check the engine oil before starting the engine. If the engine was running, switch it off and wait some minutes for the engine oil to flow back into the sump before checking it. Pull out the dipstick, wipe it with a clean, non-fluffy cloth, re-insert it completely and pull it out once more.

If the level lies between the marks, there is no need to refill. Hot oil may exceed the MAX mark by some millimetres due to thermal expansion.

If it lies at the MIN mark refill using only engine oil meeting the Ford specification.

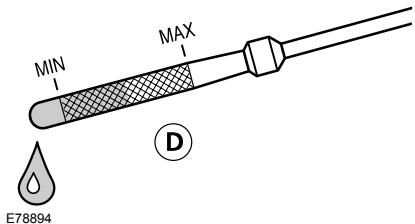
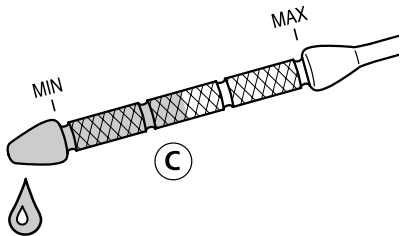
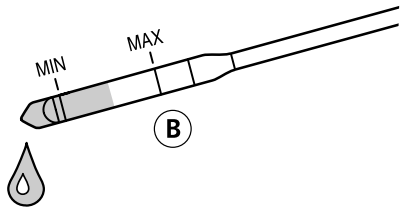
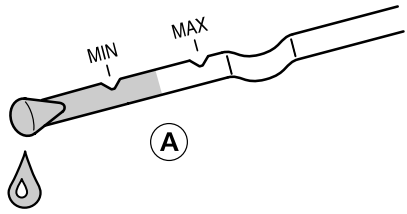

E78894

- A 1.4/1.6 | Duratec/1.6 | Duratec Ti-VCT engine
- B 1.8/2.0 | Duratec-HE engine

Maintenance

- C 1.6 l Duratorq-TDCi engine
- D 1.8 l Duratorq-TDCi engine

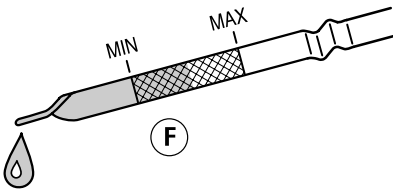
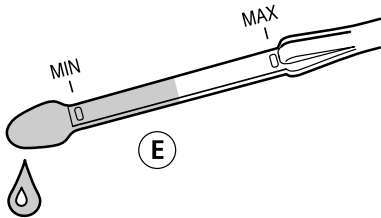

E78895

- D 2.0 l Duratorq-TDCi engine
- E 2.5 l Duratec-ST engine

Top up to only the upper mark (MAX).

Engine oil filler cap

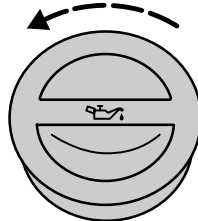
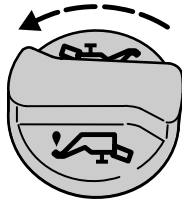
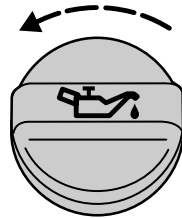

E78896

The oil filler cap is a twist-on fit design. To open, turn the cap anti-clockwise. Do not open the cap while the engine is running.

WARNING

 Make sure the cap is twisted on tightly. Undertightening could allow oil to leak out.

To close, turn the cap clockwise until a strong resistance is felt.

Maintenance

Engine oil change

Except vehicles with a Flexfuel engine

Use Ford/Motorcraft **Formula E SAE 5W-30** engine oil.

Alternative engine oils with the viscosity **SAE 5W-30** meeting the requirements of Ford Specification **WSS-M2C913-B** may also be used.

Vehicles with a Flexfuel engine

Note: The oil and oil filter must be changed every 10 000 km (6 000 miles) or once a year, whichever occurs first.

Use Ford/Motorcraft **Formula-S SAE 5W-40** synthetic engine oil.

Alternative engine oils with viscosity **SAE 5W-40** meeting the requirements of specification **ACEA A3/B3** may also be used.

Engine oil top-up

Except vehicles with a Flexfuel engine

If you are unable to find an oil that meets this specification, you must use an oil of the viscosity **SAE 5W-30**, **SAE 5W-40** or **SAE 10W-40**, according to ambient temperatures, meeting the requirements of either **ACEA A1/B1** or **ACEA A3/B3** specifications. Use of these oils may result in longer cranking periods, reduced engine performance, reduced fuel economy, and increased emission levels.

Vehicles with a Flexfuel engine

If you are unable to find an oil that meets this specification, you must use an oil of the viscosity **SAE 5W-30** or **SAE 10W-40**, according to ambient temperatures, meeting the requirements of either **ACEA A1/B1** or **ACEA A3/B3**. Use of these oils may result in longer cranking periods, reduced engine performance, reduced fuel economy and increased emission levels.

ENGINE COOLANT CHECK



E78154

WARNING

 To avoid scalding, never remove the cap from the coolant reservoir when the engine is hot. Do not restart the engine until the problem has been eliminated.

Maintenance

The coolant level is visible through the translucent reservoir.

The coolant level should be between the **MIN** and the **MAX** mark when the engine is cold. Hot coolant expands and may, therefore, extend beyond the **MAX** mark.

WARNING



Take great care when adding coolant. Avoid spillage on any part of the engine.

The coolant should be added when the engine is cold. If coolant has to be added when the engine is hot, first wait 10 minutes for the engine to cool. Unscrew the cap slowly. Any pressure will escape while you are turning the cap. Fully remove the cap.

Add coolant that meets the Ford Specification. See **Technical specifications** (page 222).

To close, turn the cap clockwise until it clicks.

When the vehicle is new, the cooling system is filled with coolant which offers anti-freeze protection down to approximately -25°C .

BRAKE AND CLUTCH FLUID CHECK

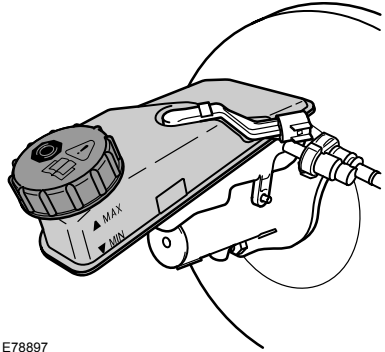

E78897

WARNING



Do not allow this fluid to make contact with the skin or eyes. If this should happen rinse the affected areas immediately with plenty of water and contact your doctor.

Note: Increased brake wear may cause the fluid level to drop. Do not add brake fluid unless the level drops below the **MIN** mark.

Brake and clutch fluid systems are supplied from the same reservoir.

The level of the fluid must lie between the **MIN** and **MAX** marks on the side of the reservoir.

Maintenance

POWER STEERING FLUID CHECK

Vehicles with a 1.4/1.6 l Duratec/1.6 l Duratec Ti-VCT engine

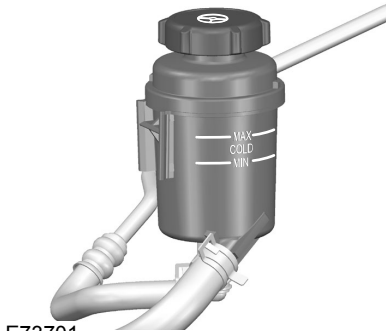

E73701

The fluid level should come up to the **MAX** mark when the engine is cold. If it drops below the **MIN** mark, top up with the specified fluid. See **Technical specifications** (page 222).

Vehicles with a 1.8/2.0 l Duratec-HE, 2.5 l Duratec-ST and Turbo diesel engines

No fluid level checks are necessary.

WASHER FLUID CHECK

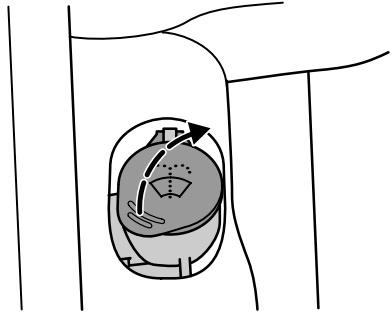

E78898

Front and rear washer systems are supplied from the same reservoir.

Replace the cap securely after topping up.

TECHNICAL SPECIFICATIONS

Vehicle fluids

Part	Recommended fluid	Specification
Power assisted steering	Ford Power Steering Fluid	WSS-M2C204-A2
Coolant	Motorcraft SuperPlus Antifreeze	WSS-M97B44-D
Brake and clutch fluid	Motorcraft Super DOT 4	ESD-M6C57-A

Maintenance

Vehicles with a petrol engine

Capacities

Variant	Item	Capacity in litres (gallons)
All	Power assisted steering fluid	Max-mark
All	Fuel tank	55 (12.1)
All	Brake and clutch fluid	Max-mark
All	Windscreen washer system - with headlamp washers	4.5 (1)
All	Windscreen washer system - without headlamp washers	3.3 (0.7)
1.4 I Duratec	Engine oil - with filter	3.8 (0.8)
1.4 I Duratec	Engine oil - without filter	3.5 (0.8)
1.4 I Duratec	Cooling system including heating - vehicles without air conditioning	5.2 (1.1)
1.4 I Duratec	Cooling system including heating - vehicles with air conditioning	5.5 (1.2)
1.6 I Duratec	Engine oil - with filter	4.1 (0.9)
1.6 I Duratec	Engine oil - without filter	3.75 (0.8)
1.6 I Duratec	Cooling system including heating - vehicles without air conditioning	5.5 (1.2)
1.6 I Duratec	Cooling system including heating - vehicles with air conditioning	5.8 (1.3)
1.6 I Duratec- Ti-VCT	Engine oil - with filter	4.1 (0.9)
1.6 I Duratec- Ti-VCT	Engine oil - without filter	3.75 (0.8)
1.6 I Duratec- Ti-VCT	Cooling system including heating	6.0 (1.3)
1.8 I Duratec-HE	Engine oil - with filter	4.3 (0.9)
1.8 I Duratec-HE	Engine oil - without filter	3.9 (0.9)

Maintenance

Variant	Item	Capacity in litres (gallons)
1.8 Duratec-HE	Cooling system including heating	6.5 (1.4)
2.0 Duratec-HE	Engine oil - with filter	4.3 (0.9)
2.0 Duratec-HE	Engine oil - without filter	3.9 (0.9)
2.0 Duratec-HE	Cooling system including heating	6.3 (1.4)
2.5 Duratec-ST	Engine oil - with filter	6.4 (1.4)
2.5 Duratec-ST	Engine oil - without filter	6.1 (1.3)
2.5 Duratec-ST	Cooling system including heating	7.1 (1.6)

Vehicles with a diesel engine

Capacities

Variant	Item	Capacity in litres (gallons)
All	Power assisted steering fluid	Max-mark
All	Fuel tank	53 (11.7)
All	Brake and clutch fluid	Max-mark
All	Windscreen washer system - with headlamp washers	4.5 (1)
All	Windscreen washer system - without headlamp washers	3.3 (0.7)
1.6 Duratorq-TDCi	Engine oil - with filter	3.8 (0.8)
1.6 Duratorq-TDCi	Engine oil - without filter	3.4 (0.7)
1.6 Duratorq-TDCi	Cooling system including heating	7.3 (1.6)
1.8 Duratorq-TDCi	Engine oil - with filter	5.6 (1.2)
1.8 Duratorq-TDCi	Engine oil - without filter	5.0 (1.1)
1.8 Duratorq-TDCi	Cooling system including heating	8.1 (1.8)
2.0 Duratorq-TDCi	Engine oil - with filter	5.5 (1.2)

Maintenance

Variant	Item	Capacity in litres (gallons)
2.0 I Duratorq-TDCi	Engine oil - without filter	5.0 (1.1)
2.0 I Duratorq-TDCi	Cooling system including heating	8.4 (1.8)



Vehicle care

CLEANING THE EXTERIOR

WARNING

 If you use a car wash with a waxing cycle, make sure that you remove the wax from the windscreen.



CAUTIONS

-  Some car wash installations use water at high pressure. This could damage certain parts of your vehicle.
 -  Remove the aerial before using an automatic car wash.
 -  Switch the heater blower off to prevent contamination of the fresh air filter.
-

We recommend that you wash your vehicle with a sponge and lukewarm water containing a car shampoo.

Cleaning the headlamps

CAUTIONS

-  Do not scrape the headlamp lenses or use abrasives or chemical solvents to clean them.
 -  Do not wipe the headlamps when they are dry.
-

Cleaning the rear window



CAUTION

 Do not scrape the inside of the rear window or use abrasives or chemical solvents to clean it.

Use a clean, lint free cloth or a damp chamois leather to clean the inside of the rear window.

Body paintwork preservation

CAUTIONS

-  Do not polish your vehicle in strong sunshine.
 -  Do not allow polish to touch plastic surfaces. It could be difficult to remove.
 -  Do not apply polish to the windscreen or rear window. This could cause the wipers to become noisy and they may not clear the window properly.
-

We recommend that you wax the paintwork once or twice a year.

CLEANING THE INTERIOR

Seat belts

WARNINGS

 Do not use abrasives, or chemical solvents to clean them.

Vehicle care

 Do not allow moisture to penetrate the seat belt retractor mechanism.

Clean the seat belts with interior cleaner or water applied with a soft sponge. Let the seat belts dry naturally, away from artificial heat.

REPAIRING MINOR PAINT DAMAGE

CAUTION

 Remove apparently harmless looking substances from the paintwork immediately (e.g. bird droppings, tree resins, insect remains, tar spots, road salt and industrial fall out).

You should repair paintwork damage caused by stones from the road or minor scratches as soon as possible. A choice of products is available from your Ford Dealer. Read and follow the manufacturer's instructions.

Vehicle battery

BATTERY CARE

The battery requires very little maintenance. The fluid level is checked regularly during the routine service inspections.

USING BOOSTER CABLES

Connect batteries with only the same nominal voltage (12 volts). Use booster cables with insulated clamps and adequate size cable. Do not disconnect the battery from the vehicle's electrical system.

To connect the booster cables

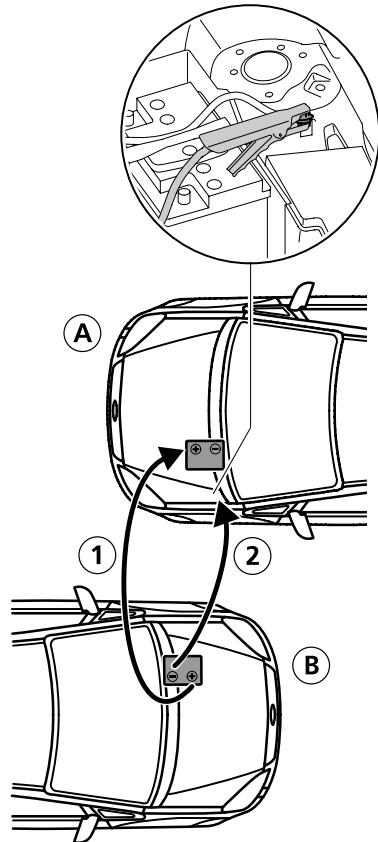

E78161

- A Flat battery
- B Booster battery

Vehicle battery

- Position the vehicles so that they do not touch one another.
- Switch off the engine. Switch off electrical equipment.
- Connect the positive (+) terminal of the flat battery to the positive (+) terminal of the booster battery.
- Connect the negative (-) terminal of the booster battery to the main body ground bolt at the left hand side suspension turret of the engine to be started. **Do not connect to the negative (-) terminal of the flat battery.**
- Make sure that the booster cables are clear of moving parts of the engine.

To start the engine

- Run the engine of the vehicle with the booster battery at moderately high speed.
- Start the engine of the vehicle with the flat battery.
- Run both vehicles for a minimum of three minutes before disconnecting the leads.

WARNING



Do not switch on the headlights when disconnecting the cables. The peak voltage could blow the bulbs.

- Disconnect the cables in the reverse order.

CHANGING THE VEHICLE BATTERY

Vehicles with a petrol engine

If the battery has been disconnected the vehicle may exhibit some unusual driving characteristics for approximately 8 km (5 miles) after battery reconnection while the engine management system realigns itself with the engine.

Wheels and tyres

CHANGING A ROAD WHEEL

Spare wheel

Your vehicle is equipped with either a spare wheel or a tyre repair kit (ContiMobilityKit). See **Tyre repair kit** (page 235).

All vehicles

WARNING

 Use only approved wheel and tyre sizes. Using other sizes could damage the vehicle and will make the National Type Approval invalid.

Vehicles with a temporary spare wheel

WARNINGS

 If the spare wheel differs from the other fitted wheels, these rules must be followed:

 Do not exceed 80 km/h (50 mph).

 Drive the shortest possible distances.

 Do not fit more than one spare wheel on your vehicle at any one time.

 Do not use snow chains on this type of wheel.

 Do not drive through an automatic car wash.

Vehicles with stability control

Vehicles with ESP may exhibit some unusual driving characteristics. Switch the ESP off. See **Using stability control** (page 175).

All vehicles

The spare wheel is located under the floor cover in the luggage compartment.

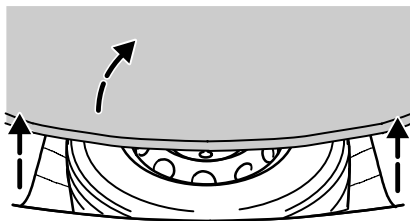

E72563

- Raise the rear of the floor cover in the luggage compartment.

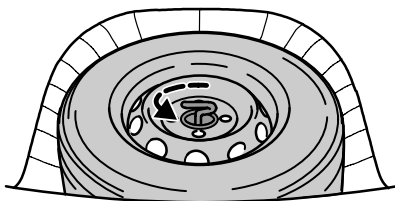

E72564

- Completely unscrew the bolt anticlockwise.
- Lift out the spare wheel.
- Remove the jack which is located beneath the spare wheel.

Wheels and tyres

Install the defective wheel in the reverse order.

Vehicle jack

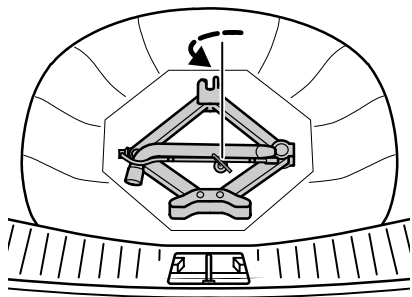

E78134

The jack and wheelbrace are located in the spare wheel well. Unscrew the retaining bolt by turning anticlockwise and remove the jack with the wheelbrace.

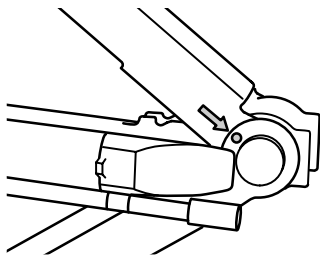

E78135

After using the jack, turn the handle until the arrow on the arm points directly towards the dot in order to attach the wheelbrace to the jack.

Clip the wheelbrace onto the jack handle and fold the handle back against the jack as shown in the graphic.

Wheel chock

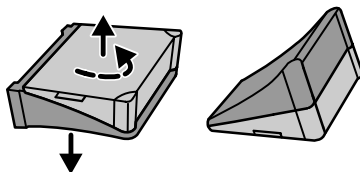

E78136

When changing a wheel, secure the diagonally opposite wheel with an appropriate block or wheel chock, if necessary.

Pull the two halves of the chock apart, and twist 180 degrees.

Jacking points

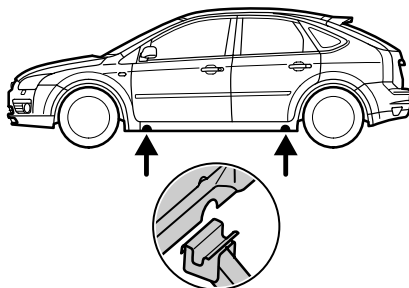

E78883

The jack must only be used on the small indentations under the sills.

Wheels and tyres

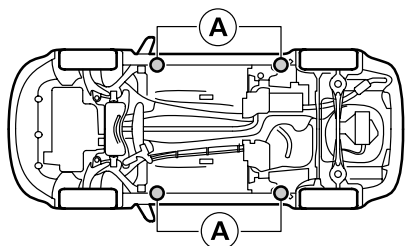

E78138

Points **A** can also be used for trolley jacks, workshop hoists or jack stands.

Positioning at other points may cause considerable damage to the body, steering, suspension, engine, braking system and fuel lines.

Removing a wheel

All vehicles

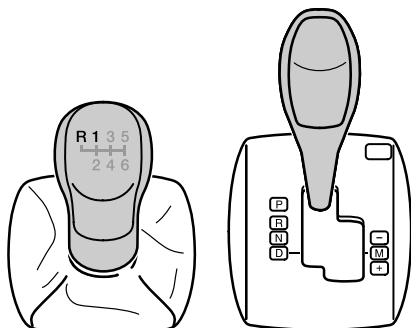
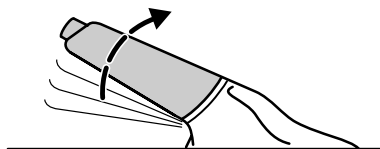



E78133

WARNINGS

 Park your vehicle in such a position that neither the traffic nor you are hindered or endangered when changing a wheel.

 Set up a warning triangle.

 Ensure that the vehicle is on firm, level ground.

 If necessary, secure the vehicle with suitable chocks.

 Point the front wheels straight ahead.

 Switch off the ignition, apply the parking brake and select first or reverse gear. If the vehicle has an automatic transmission, select the P position.

 Have the passengers leave the vehicle.

 If your vehicle is fitted with directional tyres, make sure that the arrows on the tyres point in the direction of rotation when the vehicle is moving forwards. The arrows on both tyre sidewalls indicate the direction of rotation.

 If a spare wheel has to be fitted with the arrows pointing in the opposite direction to the direction of rotation, have the tyre remounted in the correct direction by an expert as soon as possible.

 The vehicle jack must only be used to carry out wheel changes. Do not work under the vehicle when it is supported only by the jack.

Wheels and tyres

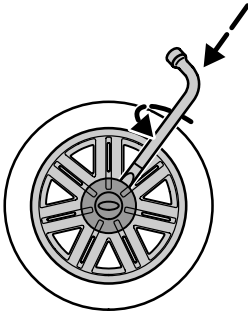

E78139

- Insert the flat end of the wheelbrace between the rim and the hub cover and twist carefully to remove the cover.

Vehicles with spoked steel wheels

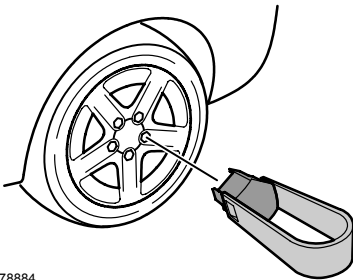

E78884

Remove the wheel nut caps using the cap puller.

Vehicles with locking wheel nuts

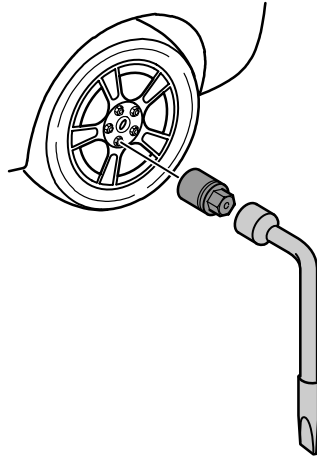

E72572

Note: Replacement locks and wheel nuts can be obtained using the wheel nut reference number certificate.

- Insert the nut key onto the locking nut.

All vehicles

- Slacken the wheel nuts.
- Place the jack with the whole foot area on firm ground.
- Jack up the vehicle until the wheel is clear of the ground.
- Unscrew and remove the wheel nuts and take off the wheel.

Wheels and tyres

Fitting a wheel

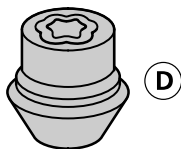
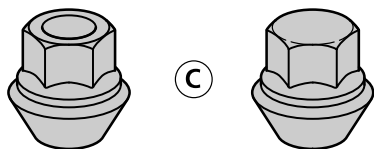
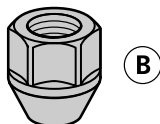
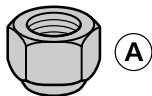

E78885

- A Wheel nuts for steel wheels
- B Wheel nuts for spoked steel wheels
- C Wheel nuts for alloy wheels
- D Locking nut

Vehicles with spoked steel wheels

Note: The wheel nuts of spoked steel wheels can also be used for the steel spare wheel for a short time (maximum two weeks).

Vehicles with alloy wheels

WARNING

 Alloy wheels must never be secured using wheel nuts for steel wheels.

Note: The wheel nuts of alloy wheels can also be used for the steel spare wheel for a short time (maximum two weeks).

All vehicles

- Push the wheel onto the wheel studs. Screw on the wheel nuts and secure in a clockwise direction ensuring that the tapered end of the wheel nuts is facing the wheel.
- Lower the vehicle and remove the jack.

Vehicles with locking wheel nuts

- Insert the nut key onto the locking nut.

Wheels and tyres

All vehicles

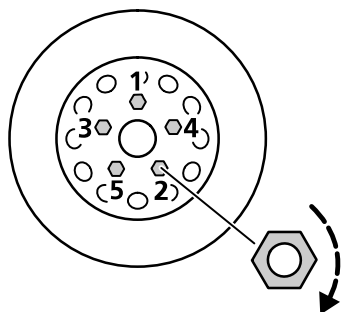

E72573

- Fully tighten the wheel nuts in the pattern shown.
- Press the hub cap firmly with the ball of the hand.
- Stow the locking nut and the wheelbrace safely.
- Stow the jack and defective wheel in reverse order and secure them.

Have the tightening torque of the wheel nuts and the tyre pressure checked as soon as possible.

TYRE CARE

If you have to mount a kerb, do so slowly and, if possible, approach it with the wheels at right-angles to the kerb. Avoid steep and sharp edged obstacles. Do not scrub the tyre sidewalls when parking.

Regularly examine the tyre surface for cuts, foreign bodies and uneven wear. An uneven tread wear pattern could indicate faulty wheel alignment.

Tyre pressure

A tyre pressure decal is located on the door pillar on the driver's side.

TYRE REPAIR KIT

General information

WARNINGS

 Compliance with these instructions is vital to ensuring vehicle safety. Non-compliance with these instructions means risking tyre damage, which can affect vehicle handling and lead to loss of vehicle control. This may result in serious injury or death.

 Do not use the ContiMobilityKit if the tyre has already been damaged as a result of being driven underinflated. Do not try to seal damage other than that located within the visible tread of the tyre. Do not try to seal damage to the tyre's sidewall.

Note: Remember that emergency roadside tyre repair kits only provide temporary mobility. Regulations concerning tyre repair after usage of ContiMobilityKit may differ from country to country. You should consult a tyre specialist for advice.

Wheels and tyres

The ContiMobilityKit seals most tyre punctures to temporarily restore mobility. The system consists of a compressor and a sealant, and serves to effectively and conveniently seal punctures in car tyres caused, for example, by nails or similar objects with a diameter of up to 6 mm (1/4 inch).

Depending on the type and extent of tyre damage, some tyres can only be partially sealed or not sealed at all. Loss of tyre pressure can affect vehicle handling, leading to loss of vehicle control.

Empty sealant bottles can be disposed of together with normal household waste. Remains of liquid sealant must be returned to your dealer or disposed of in compliance with local waste disposal regulations.

Using the ContiMobilityKit safely

- Drive with caution and avoid making sudden steering or driving manoeuvres, especially if the vehicle is heavily loaded or you are towing a trailer.
- The system will provide you with an emergency temporary repair, enabling you to continue your journey to the next vehicle or tyre dealer, or to drive a maximum distance of 200 km (125 miles).
- Do not exceed a maximum speed of 80 km/h (50 mph).
- Store the ContiMobilityKit safely and secure it in the vehicle's luggage compartment. Storing it anywhere in the passenger compartment is not advisable as it could strike an occupant in the event of a sudden stop or collision and cause injury.
- Keep the ContiMobilityKit out of the reach of children.
- Use the ContiMobilityKit only for the vehicle with which it was supplied.
- If used for other than its intended purpose, the ContiMobilityKit may cause severe accident or injury due to the fact that compressed air can act as an explosive or propellant.
- Park your vehicle at the roadside so that you do not obstruct the flow of traffic and so that you are able to use the ContiMobilityKit without being in danger.
- Apply the parking brake, even if you have parked on a level road, to make sure that the vehicle will not move.
- Do not attempt to remove foreign objects like nails or screws penetrating the tyre. Leave them as they are.
- Leave the engine running while the ContiMobilityKit is in use, but not if the vehicle is in an enclosed or poorly ventilated area.
- Never leave the ContiMobilityKit unattended while in use.

Wheels and tyres

- Do not keep the compressor operating for more than 10 minutes otherwise there is a risk of it overheating.
- Replace the sealant canister with a new one before the expiration date (see top of bottle) is reached.

Repairing a puncture

You can temporarily repair a tyre puncture in two steps.

First pump the tyre sealant and air into the tyre (see Step 1). Immediately thereafter, drive a short distance (3 km) in order to distribute the sealant in the tyre. After that, check the tyre pressure and pump more air into the tyre if necessary (see Step 2).

Inform all other users of the vehicle that the tyre has been temporarily sealed with the ContiMobilityKit and make them aware of the special driving conditions to be observed.

Step 1: Pumping the tyre sealant and air into the tyre

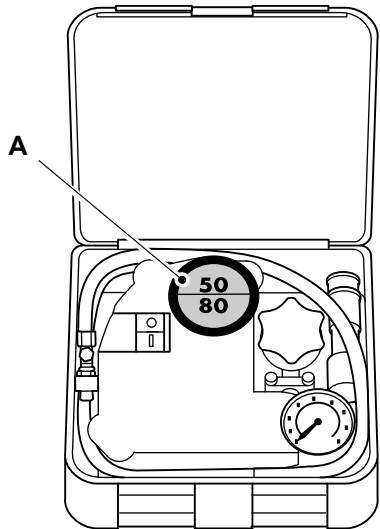

E75436

Open the lid. Peel off the label **A** denoting the maximum permissible speed of 80 km/h (50 mph) from the casing and attach it to the instrument panel in the driver's field of view.

Wheels and tyres

Unscrew the orange cap **D** of the bottle holder and the lid **E** of the sealant bottle.

WARNING

 Screwing the bottle onto the bottle holder will pierce the seal of the bottle. Do not unscrew the full sealant bottle from the holder otherwise the sealant will run out of the bottle.

Screw the bottle clockwise into the bottle holder **F** until it is screwed tight.

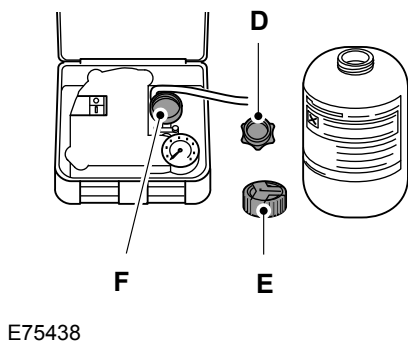
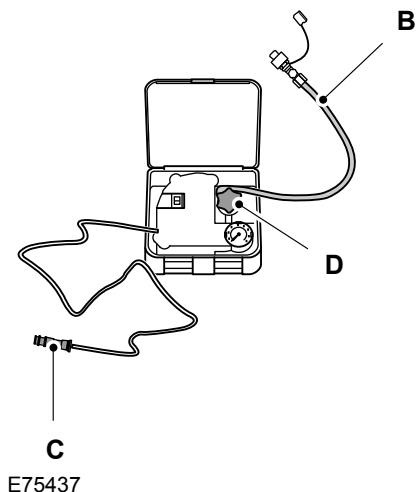

Take the hose **B** and power plug **C** with cable out of the ContiMobiKit casing.

Put on the enclosed gloves. Avoid skin contact with the sealant which contains natural rubber latex.

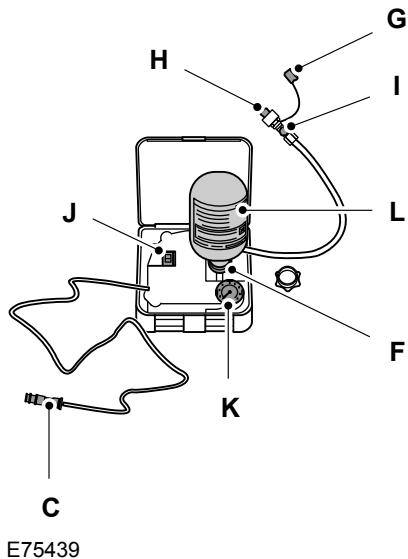

Remove the valve cap from the damaged tyre.

Wheels and tyres

Pull the protective cap **G** off the end of the hose and screw the hose **H** firmly onto the valve of the damaged tyre.

Make sure that the compressor switch **J** is switched to **O**.

Insert power plug **C** into the cigar lighter socket or auxiliary power socket.

Start the engine (only if the vehicle is outdoors or in a well ventilated area).

WARNING

 Check the sidewall of the tyre prior to inflation. If there are any cracks, bumps or similar damage, do not attempt to inflate the tyre. Do not stand directly beside the tyre while the compressor is pumping. Watch the sidewall of the tyre. If any cracks, bumps or similar damage appear, turn off the compressor and let the air out by means of the pressure relief valve **I**. In this case, do not continue driving with this tyre.

Note: When pumping in the sealant through the tyre valve, the pressure may rise up to 6 bar but will drop again after about 30 seconds.

Press compressor switch **J** to **I**.

WARNING

 If the tyre inflation pressure does not reach 1.8 bar within 7 minutes, the tyre may have suffered excessive damage, making a temporary repair impossible. In this case, do not continue driving with this tyre.

Inflate the tyre for no longer than 7 minutes to an inflation pressure of minimum 1.8 bar and a maximum of 3.5 bar. Switch off the compressor briefly in order to read the current tyre pressure from the pressure gauge **K**.

Once a tyre inflation pressure of at least 1.8 bar has been reached, switch the compressor to **O**.

Remove the power plug from the cigar lighter socket or auxiliary power socket.

Quickly unscrew the hose from the tyre valve and replace the protective cap **G**. Fasten the valve cap again.

Leave the bottle in the holder.

Make sure the ContiMobilityKit, the lid of the bottle and the orange cap are stored safely, but are still easily accessible, in the vehicle. The kit will be needed again when you check the tyre pressure.

Wheels and tyres

WARNING

 If heavy vibrations, unsteady steering behavior or noises should occur while driving, reduce your speed and drive with caution to a place where it is safe for you to stop the vehicle. Recheck the tyre and its pressure. If the tyre pressure is less than 1.3 bar or if there are any cracks, bumps or similar damage visible, do not continue driving with this tyre.

Immediately start and drive for about 3 km (2 miles) so that the sealant can seal the damaged area. Do not drive any faster than 80 km/h (50 mph) (observe the sticker indicating the maximum permissible speed).

Checking the tyre pressure

Stop the vehicle after driving about 3 km (2 miles). Check and, where necessary, adjust the pressure of the damaged tyre.

Remove the protective cap **G** from the end of the hose.

Screw the hose **H** firmly onto the valve of the damaged tyre.

Read the tyre pressure from the pressure gauge **K**.

If the pressure of the sealant-filled tyre is 1.3 bar or more, it must now be adjusted to the pressure specified for your vehicle.

Make sure that the compressor switch **J** is switched off to **O**.

Insert the power plug **C** into the cigar lighter socket or auxiliary power socket.

WARNING

 It may cause asphyxiation if the engine is allowed to run in a non-ventilated or poorly ventilated area (e.g. inside a building).

Start the engine (only if the vehicle is outdoors or in a well ventilated area).

Switch the compressor on to **I** and pump the tyre up to the specified tyre pressure.

Switch the compressor off and check the tyre pressure again. If tyre pressure is too high, deflate the tyre to the specified pressure using the pressure relief valve **I**.

Once you have inflated the tyre to its correct tyre pressure, switch off the compressor, remove the plug from the socket, unscrew the hose, fasten the valve cap and replace the protective cap **G**.

Leave the bottle in the holder and store the ContiMobilityKit away safely in the luggage compartment.

WARNING

 Before driving, ensure tyre is adjusted to recommended inflation pressure. Monitor tyre pressure until the sealed tyre is replaced. Proceed as described above from point 2 onwards in the section Step 2: Checking the tyre pressure.

Wheels and tyres

Drive to the nearest expert to get the damaged tyre replaced. Before the tyre is removed from the rim, inform your tyre dealer that the tyre contains sealant (see separate tyre demounting instructions). Both the hose and the canister of sealant need to be replaced after using the ContiMobilityKit. Sealant deposits in a used hose may impair proper functioning of the ContiMobilityKit.

USING WINTER TYRES

If winter tyres are used, the tyre pressures recommended by the tyre manufacturers should be adhered to.

USING SNOW CHAINS

Note: Snow chains must not be fitted to 205/50 R 17 or 225/40 R 18 tyres.

TECHNICAL SPECIFICATIONS

Except FocusST and convertible

Up to 160 km/h (100 mph)

Tyre pressures

Variant	Tyre size	Normal load		Full load	
		Front	Rear	Front	Rear
		bar (lbf/in ²)	bar (lbf/in ²)	bar (lbf/in ²)	bar (lbf/in ²)
All - temporary spare tyre - 80 km/h (50 mph) MAX	T125/85 R 16	4.2 (61)	4.2 (61)	4.2 (61)	4.2 (61)

Use only the recommended small link snow chains on the driving wheels (front).

Do not exceed 50 km/h (30 mph). Remove the chains immediately on snow-free roads.

The ABS system will continue to function normally.

In order to avoid damaging full-diameter wheel covers, they should be removed before driving with snow chains.

Vehicles with stability control (ESP)

Vehicles with stability control (ESP) may exhibit some unusual driving characteristics which can be avoided by switching the system off. See **Using stability control** (page 175).

Wheels and tyres

Variant	Tyre size	Normal load		Full load	
		Front	Rear	Front	Rear
		bar (lbf/in ²)	bar (lbf/in ²)	bar (lbf/in ²)	bar (lbf/in ²)
All	195/65 R 15	2.1 (31)	2.3 (33)	2.4 (35)	2.8 (41)
All	205/50 R 17	2.3 (33)	2.3 (33)	2.5 (36)	2.8 (41)
All	225/40 R 18	2.3 (33)	2.3 (33)	2.5 (36)	2.8 (41)
Vehicles with a petrol engine	205/55 R 16	2.1 (31)	2.3 (33)	2.4 (35)	2.8 (41)
Vehicles with a diesel engine	205/55 R 16	2.3 (33)	2.3 (33)	2.4 (35)	2.8 (41)

Continuous speed in excess of 160 km/h (100 mph)

Tyre pressures

Variant	Tyre size	Normal load		Full load	
		Front	Rear	Front	Rear
		bar (lbf/in ²)	bar (lbf/in ²)	bar (lbf/in ²)	bar (lbf/in ²)
All	195/65 R 15	2.4 (35)	2.3 (33)	2.6 (38)	3.0 (44)
All	205/50 R 17	2.5 (36)	2.3 (33)	2.7 (39)	3.0 (44)
All	225/40 R 18	2.5 (36)	2.3 (33)	2.7 (39)	3.0 (44)
Vehicles with a petrol engine	205/55 R 16	2.4 (35)	2.3 (33)	2.6 (38)	3.0 (44)
Vehicles with a diesel engine	205/55 R 16	2.4 (35)	2.3 (33)	2.6 (38)	3.0 (44)

FocusST

Wheels and tyres

Up to 160 km/h (100 mph)

Tyre pressures

Variant	Tyre size	Normal load		Full load	
		Front	Rear	Front	Rear
		bar (lbf/in ²)	bar (lbf/in ²)	bar (lbf/in ²)	bar (lbf/in ²)
All - temporary spare tyre - 80 km/h (50 mph) MAX	T125/85 R 16	4.2 (61)	4.2 (61)	4.2 (61)	4.2 (61)
All	205/55 R 16	2.3 (33)	2.3 (33)	2.3 (33)	2.3 (33)

Up to 190 km/h (118 mph)

Tyre pressures

Variant	Tyre size	Normal load		Full load	
		Front	Rear	Front	Rear
		bar (lbf/in ²)	bar (lbf/in ²)	bar (lbf/in ²)	bar (lbf/in ²)
All	225/40 R 18	2.3 (33)	2.3 (33)	2.3 (33)	2.3 (33)

Continuous speed in excess of 160 km/h (100 mph)

Tyre pressures

Variant	Tyre size	Normal load		Full load	
		Front	Rear	Front	Rear
		bar (lbf/in ²)	bar (lbf/in ²)	bar (lbf/in ²)	bar (lbf/in ²)
All	205/55 R 16	2.5 (36)	2.3 (33)	2.7 (39)	2.3 (33)

Continuous speed in excess of 190 km/h (118 mph)

Tyre pressures

Variant	Tyre size	Normal load		Full load	
		Front	Rear	Front	Rear
		bar (lbf/in ²)	bar (lbf/in ²)	bar (lbf/in ²)	bar (lbf/in ²)
All	225/40 R 18	2.6 (38)	2.3 (33)	2.8 (41)	2.4 (35)

Wheels and tyres

Convertible

Up to 160 km/h (100 mph)

Tyre pressures

Variant	Tyre size	Normal load		Full load	
		Front	Rear	Front	Rear
		bar (lbf/in ²)	bar (lbf/in ²)	bar (lbf/in ²)	bar (lbf/in ²)
All - temporary spare tyre - 80 km/h (50 mph) MAX	T125/85 R 16	4.2 (61)	4.2 (61)	4.2 (61)	4.2 (61)
All	205/55 R 16	2.3 (33)	2.5 (36)	2.3 (33)	2.5 (36)
All	205/50 R 17	2.3 (33)	2.5 (36)	2.3 (33)	2.5 (36)
All	225/40 R 18	2.3 (33)	2.3 (33)	2.3 (33)	2.5 (36)

Continuous speed in excess of 160 km/h (100 mph)

Tyre pressures

Variant	Tyre size	Normal load		Full load	
		Front	Rear	Front	Rear
		bar (lbf/in ²)	bar (lbf/in ²)	bar (lbf/in ²)	bar (lbf/in ²)
All	205/55 R 16	2.3 (33)	2.5 (36)	2.5 (36)	2.7 (39)
All	205/50 R 17	2.3 (33)	2.5 (36)	2.5 (36)	2.7 (39)
All	225/40 R 18	2.3 (33)	2.3 (33)	2.5 (36)	2.7 (39)

Vehicle identification

VEHICLE IDENTIFICATION PLATE

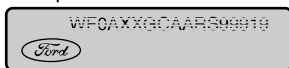
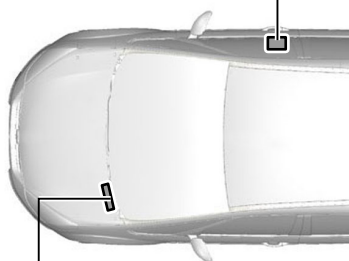
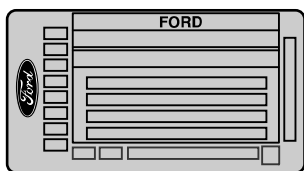

E75441

The vehicle identification plate is located on the B-pillar. This plate bears information on vehicle type, identification number, vehicle weights and it identifies various components.

VEHICLE IDENTIFICATION NUMBER (VIN)

The vehicle identification number is stamped onto the plastic tag on the left-hand side of the instrument panel.

ENGINE NUMBER

Depending on the engine type, the engine number is located (seen in the direction of travel):

1.4/1.6 | Duratec/Duratec Ti-VCT

at the front of the engine block, on the left-hand side.

1.8/2.0 | Duratec-HE and 2.5 | Duratec-ST

at the rear of the engine block, on the left-hand side.

1.6/2.0 | Duratorq-TDCi Turbo diesel

on the engine block, next to the oil filter/cooler.

1.8 | Duratorq-TDCi Turbo diesel

on the intake manifold.

Technical specifications

TECHNICAL SPECIFICATIONS

Vehicle dimensions

3-door and 5-door

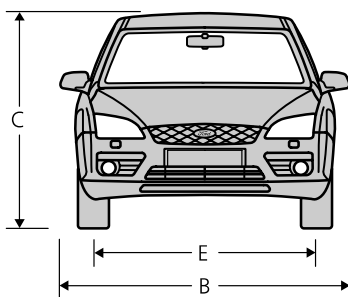
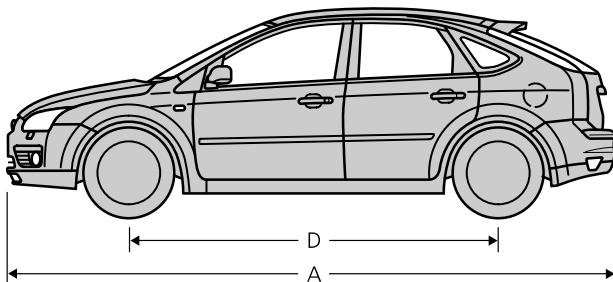
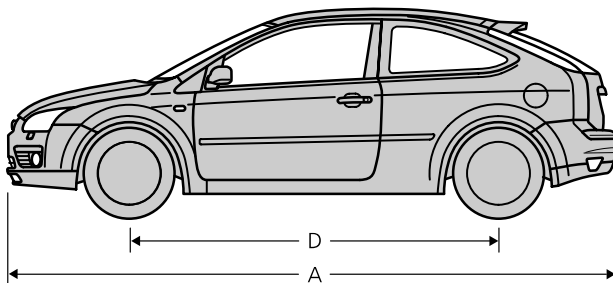

E78899

Technical specifications

Item	Dimension description	Dimension in mm (inches)
A	Maximum length - Except FocusST	4342 (170.9)
A	Maximum length - FocusST	4362 (171.7)
B	Overall width - incl. exterior mirrors	1991 (78.4)
C	Overall height - EC kerb weight	1454-1497 (57.2-58.9)
D	Wheelbase	2640 (103.9)
E	Front track	1535 (60.4)
E	Rear track	1531 (60.3)

4-door

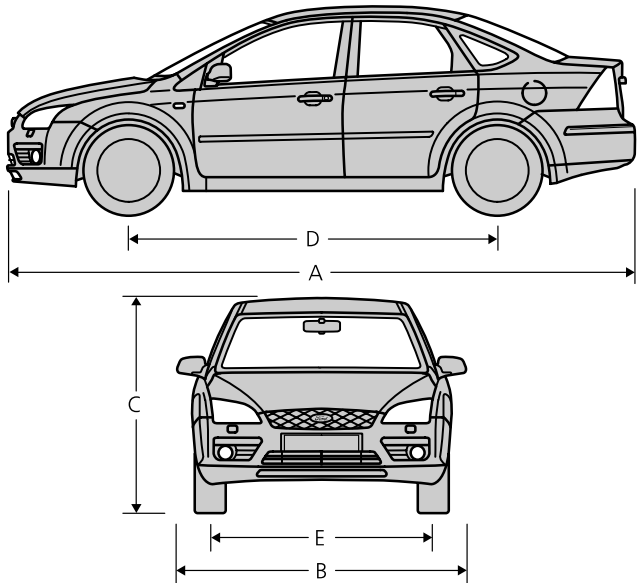

E78900

Technical specifications

Item	Dimension description	Dimension in mm (inches)
A	Maximum length	4488 (176.7)
B	Overall width - incl. exterior mirrors	1991 (78.4)
C	Overall height - EC kerb weight	1454-1497 (57.2-58.9)
D	Wheelbase	2640 (103.9)
E	Front track	1535 (60.4)
E	Rear track	1531 (60.3)

Estate

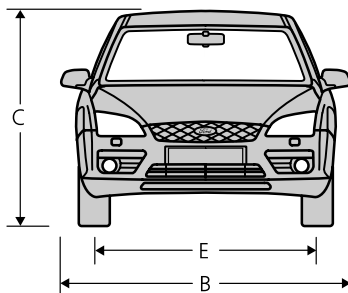
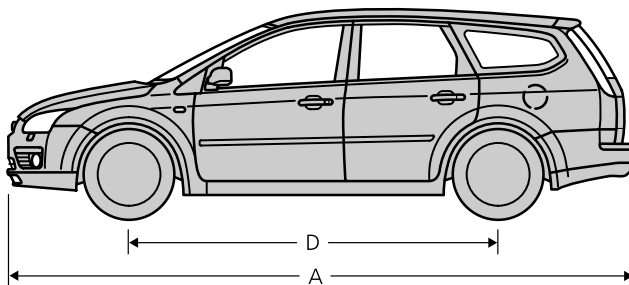

E78901

Item	Dimension description	Dimension in mm (inches)
A	Maximum length	4472 (176.1)
B	Overall width - incl. exterior mirrors	1991 (78.4)

Technical specifications

Item	Dimension description	Dimension in mm (inches)
C	Overall height - EC kerb weight	1459-1501 (57.4-59.1)
D	Wheelbase	2640 (103.9)
E	Front track	1535 (60.4)
E	Rear track	1531 (60.3)

Technical specifications

Convertible

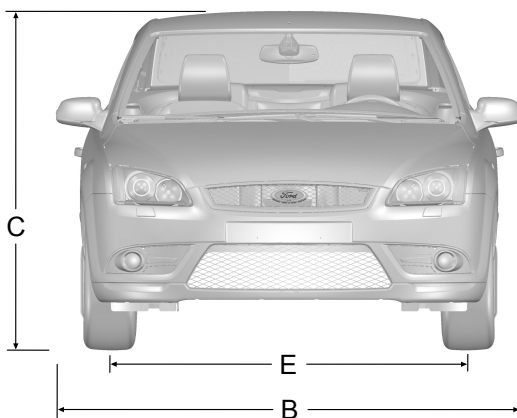
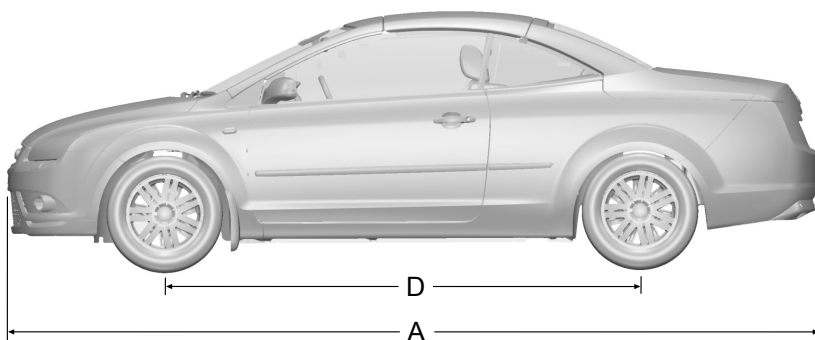

E79625

Item	Dimension description	Dimension in mm (inches)
A	Maximum length	4509 (177.5)
B	Overall width - incl. exterior mirrors	1991 (78.4)
C	Overall height - EC kerb weight	1456 (57.3)
D	Wheelbase	2640 (103.9)

Technical specifications

Item	Dimension description	Dimension in mm (inches)
E	Front track	1535 (60.4)
E	Rear track	1531 (60.3)

Towing equipment dimensions

3-door and 5-door

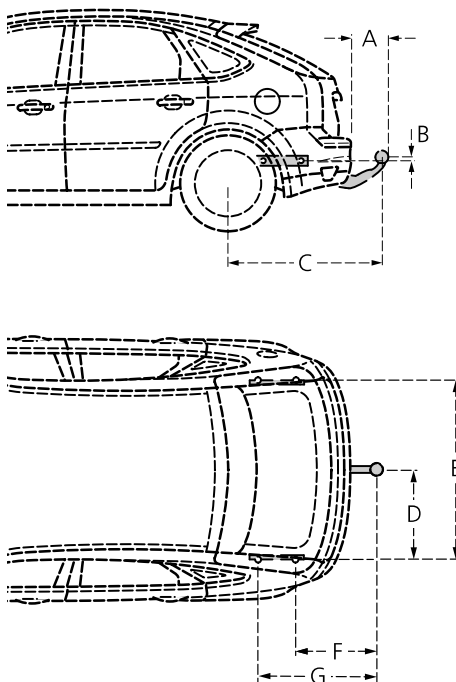

E78902

Item	Dimension description	Dimension in mm (inches)
A	Bumper - end of tow ball	102.5 (4)
B	Attachment point - centre of tow ball	57.9 (2.3)

Technical specifications

Item	Dimension description	Dimension in mm (inches)
C	Wheel centre – centre of tow ball	899.9 ±2.5 (35.4)
D	Centre of tow ball – side member	515.4 ±2.5 (20.3)
E	Distance between side members	1030.9 ±5 (40.6)
F	Centre of towball – centre 1. attachment point	399.5 ±2.5 (15.7)
G	Centre of towball – centre 2. attachment point	699.5 ±2.5 (27.5)

All measurements refer to towing equipment officially released by Ford.

4-door

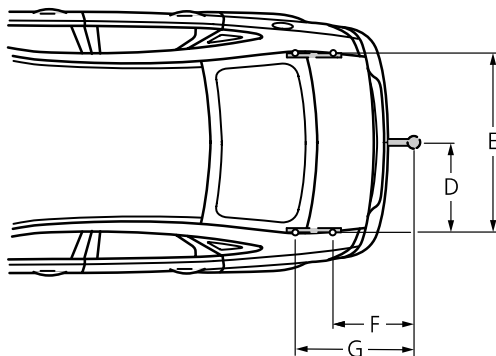
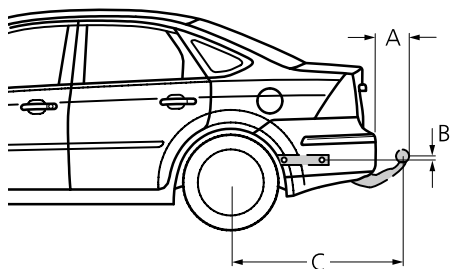

E78903

Technical specifications

Item	Dimension description	Dimension in mm (inches)
A	Bumper – end of tow ball	96 (3.8)
B	Attachment point – centre of tow ball	48.2 (1.9)
C	Wheel centre – centre of tow ball	1038 (40.9)
D	Centre of tow ball – side member	515.5 ±2.5 (20.3)
E	Distance between side members	1031 ±5 (40.6)
F	Centre of towball – centre 1. attachment point	423.8 ±2.5 (16.7)
G	Centre of towball – centre 2. attachment point	723.8 ±2.5 (28.5)

All measurements refer to towing equipment officially released by Ford.

Technical specifications

Estate

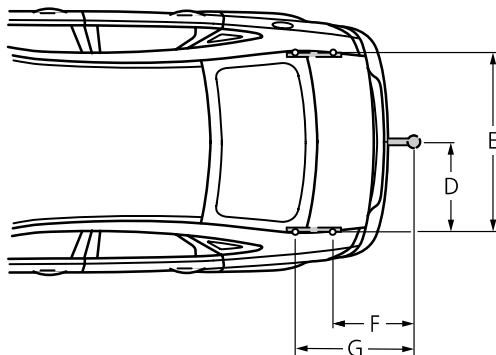
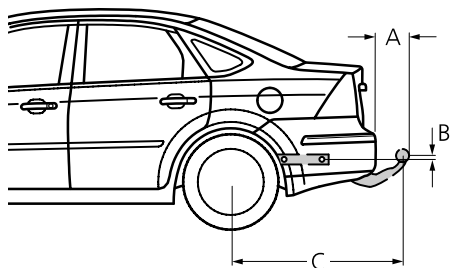

E78903

Item	Dimension description	Dimension in mm (inches)
A	Bumper – end of tow ball	125 (4.9)
B	Attachment point – centre of tow ball	56.5 (2.2)
C	Wheel centre – centre of tow ball	1059.5 (41.7)
D	Centre of tow ball – side member	588.5 ±2.5 (23.2)
E	Distance between side members	1176.9 ±5 (46.3)
F	Centre of towball – centre 1. attachment point	433 ±2.5 (17)
G	Centre of towball – centre 2. attachment point	683 ±2.5 (26.9)
All measurements refer to towing equipment officially released by Ford.		

Technical specifications

Convertible

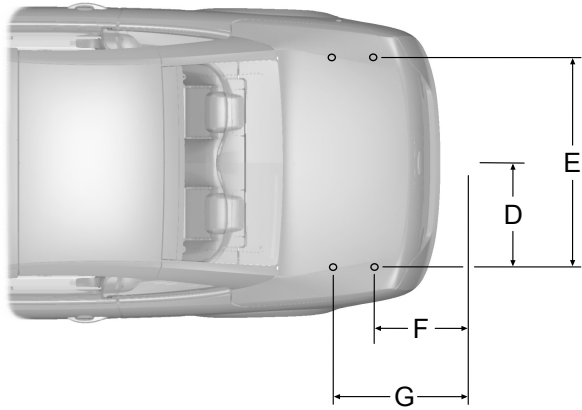
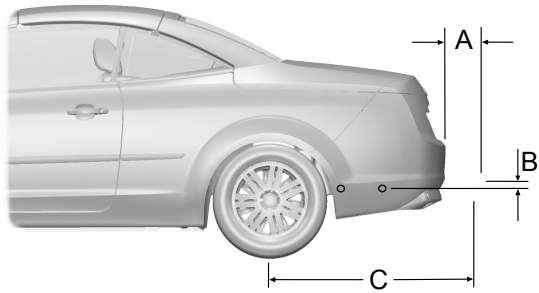

E79626

Item	Dimension description	Dimension in mm (inches)
A	Bumper – end of tow ball	95 (3.7)
B	Attachment point – centre of tow ball	6 (0.2)
C	Wheel centre – centre of tow ball	1064 (41.9)
D	Centre of tow ball – side member	517 (20.4)
E	Distance between side members	1034 (40.7)

Technical specifications

Item	Dimension description	Dimension in mm (inches)
F	Centre of towball – centre 1. attachment point	443 (17.4)
G	Centre of towball – centre 2. attachment point	743 (29.3)
All measurements refer to towing equipment officially released by Ford.		

Vehicle weights

1.4 I Duratec

Item	Weight (kg)			
	3-door	4-door	5-door	Estate
EC kerb weight	1229	1272	1247	1277
Payload	461	463	463	473
Permissible gross weight	1690	1735	1710	1750
Permissible roof rack weight	75	75	75	75

1.6 I Duratec with manual transmission

Item	Weight (kg)				
	3-door	4-door	5-door	Estate	Convert-ible
EC kerb weight	1227	1270	1249	1277	1473
Payload	483	480	481	543	397
Permissible gross weight	1710	1750	1730	1820	1870
Permissible roof rack weight	75	75	75	75	-

Technical specifications

1.6 I Duratec with automatic transmission

Item	Weight (kg)			
	3-door	4-door	5-door	Estate
EC kerb weight	1255	1308	1286	1308
Payload	485	472	469	537
Permissible gross weight	1740	1780	1755	1845
Permissible roof rack weight	75	75	75	75

1.6 I Duratec Ti-VCT

Item	Weight (kg)			
	3-door	4-door	5-door	Estate
EC kerb weight	1239	1279	1257	1279
Payload	481	486	483	546
Permissible gross weight	1720	1765	1740	1825
Permissible roof rack weight	75	75	75	75

1.8 I Duratec-HE

Item	Weight (kg)			
	3-door	4-door	5-door	Estate
EC kerb weight	-	-	1319	1351
Payload	-	-	476	544
Permissible gross weight	-	-	1795	1895
Permissible roof rack weight	-	-	75	75

Technical specifications

2.0 | Duratec-HE with manual transmission

Item	Weight (kg)				
	3-door	4-door	5-door	Estate	Convertible
EC kerb weight	1307	1341	1327	1359	1525
Payload	468	469	468	536	425
Permissible gross weight	1775	1810	1795	1895	1950
Permissible roof rack weight	75	75	75	75	-

2.0 | Duratec-HE with automatic transmission

Item	Weight (kg)			
	3-door	4-door	5-door	Estate
EC kerb weight	1320	1362	1339	1371
Payload	465	458	466	534
Permissible gross weight	1785	1820	1805	1905
Permissible roof rack weight	75	75	75	75

2.5 | Duratec-ST

Item	Weight (kg)			
	3-door	4-door	5-door	Estate
EC kerb weight	1392	-	1437	-
Payload	468	-	453	-
Permissible gross weight	1860	-	1890	-
Permissible roof rack weight	75	-	75	-

Technical specifications

1.6 I Duratorq-TDCi 66 kW (90 PS)

Item	Weight (kg)			
	3-door	4-door	5-door	Estate
EC kerb weight	1335	1377	1352	1386
Payload	440	438	438	494
Permissible gross weight	1775	1815	1790	1880
Permissible roof rack weight	75	75	75	75

1.6 I Duratorq-TDCi 80 kW (109 PS), Stage III emissions

Item	Weight (kg)			
	3-door	4-door	5-door	Estate
EC kerb weight	1333	1377	1352	1386
Payload	442	438	438	494
Permissible gross weight	1775	1815	1790	1880
Permissible roof rack weight	75	75	75	75

1.6 I Duratorq-TDCi 80 kW (109 PS), Stage IV emissions with DPF

Item	Weight (kg)			
	3-door	4-door	5-door	Estate
EC kerb weight	1339	1384	1357	1391
Payload	441	436	438	494
Permissible gross weight	1780	1820	1795	1885
Permissible roof rack weight	75	75	75	75

Technical specifications

1.6 I Duratorq-TDCi 80 kW (109 PS) with Durashift CVT

Item	Weight (kg)			
	3-door	4-door	5-door	Estate
EC kerb weight	1358	1393	1380	1409
Payload	432	442	435	476
Permissible gross weight	1790	1835	1815	1885
Permissible roof rack weight	75	75	75	75

1.8 I Duratorq-TDCi

Item	Weight (kg)			
	3-door	4-door	5-door	Estate
EC kerb weight	1374	1416	1392	1426
Payload	486	489	483	524
Permissible gross weight	1860	1905	1875	1950
Permissible roof rack weight	75	75	75	75

2.0 I Duratorq-TDCi, Stage III emissions

Item	Weight (kg)			
	3-door	4-door	5-door	Estate
EC kerb weight	1369	1425	1383	1429
Payload	481	470	482	521
Permissible gross weight	1850	1895	1865	1950
Permissible roof rack weight	75	75	75	75

Technical specifications

2.0 I Duratorq-TDCi, Stage IV emissions with DPF

Item	Weight (kg)				
	3-door	4-door	5-door	Estate	Convert-ible
EC kerb weight	1378	1435	1391	1438	1608
Payload	482	470	484	512	437
Permissible gross weight	1860	1905	1875	1950	2045
Permissible roof rack weight	75	75	75	75	-

Type approvals

Remote control

Type 1

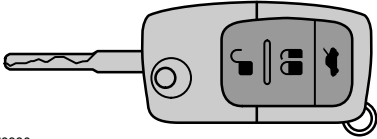

E78380

If the type approval of your remote control is inspected, refer to the table below. It is recommended that you use the remote control only in the countries listed.

Type approvals

Type approval of the remote control	
Country	Official test number
(A) (AL) (AND) (B) (BIH) (CH) (CY) (D) (DK) (E) (F) (FIN) (GB) (GBZ) (GR) (H) (HR) (I) (IRL) (L) (M) (MK) (N) (NL) (P) (RO) (S) (SLO) (TR) (UA) (YU)	Siemens VDO, 5WK4 8791, CE ¹
(ARM) (RUS)	- ²
(BG)	Siemens VDO, 5WK4 8791, G
(CZ)	Siemens VDO, 5WK4 8791, CZ ¹
(IL)	Siemens VDO, 5WK4 8791, 00590-2003
(J)	Siemens VDO, 5WK4 8793
(PL)	Siemens VDO, 5WK4 8791, CLBT/C/101/2003
(RC)	 電波 92L.P0323
(SK)	Siemens VDO, 5WK4 8791, CSK ¹

1 Hereby, Siemens VDO declares that this remote control is in compliance with the essential requirements and other relevant provisions of Directive 1999/5/EC.

2 Data not available at the time of printing.

Type approvals





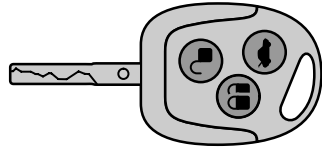

Type 2

If the type approval of your remote control is inspected, refer to the table below. It is recommended that you use the remote control only in the countries listed.



E78382

Type approvals

Type approval of the remote control	
Country	Official test number
(A) (B) (D) (DK) (E) (F) (FIN) (GB) (GR) (H) (I) (IRL) (IS) (L) (N) (NL) (P) (S)	 0499  ¹
(AUS) (BR) (GBZ) (M) (TR)	SIEMENS 433,92 MHz 5WK 4 725/8686/8071
(CH)	BAKOM 97.0946.K.P.
(CY)	MCW 129/95 23/1997
(CZ)	 <div style="border: 1px solid black; padding: 2px; display: inline-block;"> ČTÚ 1999 2 R 712 </div> 
(IL)	272/3-1998
(NZ)	
(PL)	542/98
(RC)	 電波 88LP0012
(SK)	<div style="border: 1px solid black; padding: 5px; display: inline-block;">  TÚ R 119 SR 1999 2 </div>
(ZA)	Ref.No.: 3K43D/3R1B9/SPLS-RX9/98

¹ Hereby, Siemens VDO declares that this remote control is in compliance with the essential requirements and other relevant provisions of Directive 1999/5/E.C.

E78383

Type approvals

Passive key

If the type approval of your passive key is inspected, refer to the table below. It is recommended that you use the passive key only in the countries listed.

Type approval of the passive key	
Country	Official test number
(A) (B) (CH) (CZ) (D) (DK) (E) (F) (FIN) (GB) (GR) (H) (I) (IRL) (L) (N) (NL) (P) (PL) (S)	Siemens VDO, 5WK 4 8794, CE ¹

¹ Hereby, Siemens VDO declares that this remote control is in compliance with the essential requirements and other relevant provisions of Directive 1999/5/EC.

E78384

Engine immobiliser

If the type approval of your engine immobilisation system is inspected, refer to the table below.











Type approvals

Type approvals of the engine immobilisation system	
Country	Official test number
(A) (AND) (B) (CH) (D) (DK) (E) (F) (FIN) (FR) (GB) (GBZ) (GR) (H) (I) (IRL) (IS) (L) (LT) (N) (NL) (P) (RO) (S) (SLO)	CE 0682 0 ¹
(AL)	143
(ARM) (IL) (SN) (UA)	- ²
(AUS) (BIH) (BM) (ET) (FP) (GAB) (J) (JA) (KN) (KWT) (MAC) (PNG) (RL) (TT) (WD) (WL) (WV)	No number required
(BDS)	340/3 Vol. II
(BG)	Ä Æ P 14 085/2002
(BRN)	DLM/GEN/18/18/16
(BRU)	DRQ-D-PREMIER-10-1996-3860-LPD2-1667
(BY)	BY/112 03.2.3.Æ A2294
(CDN)	3043104475A

1 Visteon Deutschland GmbH declares that the immobiliser system transceiver complies with the appropriate essential requirements of the Article 3 of the R&TTE and the other relevant provisions.

2 Data not available at the time of printing.

Type approvals

Type approvals of the engine immobilisation system	
Country	Official test number
	ESP 0201430
	 ME 83 POCC DE.ME 83.B02099
	IDA approved part LPRE Q-0259-2002
	171
	B.61.TK.0.22.00.00/4940-2632
	5/10-2/3274/3774
 	NT8-15607PAT3XCVR
	11/1 01 009/2002 006
	SPLS/RX-485/2001

E78907

 A-00 0280

 97RA-00 0001

 A-00 2108

 97RA-01 2108

E78387

Index

A

- A/C
 - See: Climate control.....125
- About this handbook.....5
- ABS
 - See: Brakes.....172
- ABS driving hints
 - See: Hints on driving with ABS.....172
- Accessories
 - See: Parts and accessories.....6
- Adaptive front lighting system (AFS).....70
- Adjusting the headlamps.....67
 - AFS headlamps.....67
 - Halogen headlamps.....67
 - Xenon headlights.....67
- Adjusting the pedals.....59
- Adjusting the steering wheel.....57
- Adjusting the windscreen washer jets.....63
- AFS
 - See: Adaptive front lighting system (AFS).....70
- Air conditioning
 - See: Climate control.....125
- Air vents.....125
- Alarm.....55
- Arming the alarm.....55
 - Automatic arming delay.....55
 - Interior sensors.....55
- Arming the engine immobiliser.....54
- Ashtray.....147
- ASL
 - See: Automatic speed limiter (ASL).....180
- Audible warnings and indicators.....102
- Automatic transmission.....102
- Electronic parking brake (EPB).....102
- Frost.....102
- Key-in-ignition.....102
- Key outside car.....102
- Lights on.....102
- Low fuel.....102
- Seat belt reminder.....102
- Stop vehicle - roof operation.....103
- Audio control.....57
 - Mode.....58
 - Seek.....58
 - Volume.....57
- Automatic climate control.....129
 - Mono mode.....130
 - Operating the automatic climate control manually.....131
 - Setting the temperature.....129
 - Switching the automatic climate control off.....132
- Automatic speed limiter (ASL).....180
 - Principle of operation.....180
- Automatic transmission.....165
 - Drive modes.....170
 - Driving with automatic transmission.....168
 - Emergency park position release lever.....171
 - General information.....165
 - Information messages.....168
 - Selector lever.....165
 - Selector lever positions.....165
- Auxiliary heater.....133
 - Auxiliary heater.....134
 - Fuel operated heater.....134
 - Programmable auxiliary heater.....133
- Auxiliary input (AUX IN) socket.....150
- Auxiliary power sockets.....147

Index

- B**
- Battery care.....228
 - Bonnet lock
 - See: Opening and closing the bonnet.....210
 - Booster cushions.....24
 - Booster cushion.....24
 - Booster seat.....24
 - Brake and clutch fluid check.....221
 - Brakes.....172
 - Principle of operation.....172
 - Bulb changing
 - See: Changing a bulb.....74
 - Bulb specification chart.....85
- C**
- Cargo nets.....182
 - Cargo net.....182
 - Cargo retention net.....182
 - Car wash
 - See: Cleaning the exterior.....226
 - Catalytic converter.....158
 - Driving with a catalytic converter.....158
 - Parking.....158
 - Centre console.....148
 - Armrest.....148
 - Ashtray.....148
 - Auxiliary power socket.....148
 - Cigar lighter.....148
 - Cup holders.....148
 - Mobile phone cradle.....148
 - Storage compartment.....149
 - Changing a bulb.....74
 - Approach lamps.....77
 - Central brake lamp.....81
 - Footwell lamp.....84
 - Front direction indicators.....75
 - Front fog lamps.....75
 - Front interior lamp.....83
 - Front reading lamps.....84
 - Headlamp dipped beam.....74
 - Headlamp main beam.....75
 - Luggage compartment lamp.....83
 - Number plate lamp.....83
 - Rear lamps - convertible.....80
 - Rear lamps - except convertible.....78
 - Removing a headlamp cover.....74
 - Side lamps.....75
 - Side repeaters.....77
 - Side repeaters on exterior mirrors.....77
 - Vanity mirror lamps.....84
 - Changing a fuse.....201
 - Changing a road wheel.....230
 - Fitting a wheel.....234
 - Jacking points.....231
 - Removing a wheel.....232
 - Spare wheel.....230
 - Vehicle jack.....231
 - Wheel chock.....231
 - Changing the remote control battery.....37
 - Opening the container.....38
 - Passive key.....37
 - Reassembling the container.....40
 - Remote control type 1.....37
 - Replacing the battery.....39
 - Changing the vehicle battery.....229
 - Vehicles with a petrol engine.....229
 - Changing the wiper blades.....64
 - Rear window wiper blades.....64
 - Windscreen wiper blades.....64
 - Checking the wiper blades.....64
 - Child safety.....22

Index

- Child safety locks.....26
Child seat positioning.....23
Child seats.....22
 Child restraints for different mass groups.....22
Cigar lighter.....146
Cleaning the exterior.....226
 Body paintwork preservation.....226
 Cleaning the headlamps.....226
 Cleaning the rear window.....226
Cleaning the interior.....226
 Seat belts.....226
Climate control.....125
 Principle of operation.....125
Closing the convertible top.....191
 Manual closure of the convertible top.....192
Coded keys.....53
 Key with remote control.....53
Convenience features.....146
Convertible top.....190
Coolant check
 See: Engine coolant check.....220
Cruise control.....178
 Principle of operation.....178
Cup holders.....147
- ## D
- Detachable tow ball.....186
 Driving with a trailer.....187
 Inserting the tow ball arm.....187
 Maintenance.....189
 Removing the tow ball arm.....188
 Unlocking the tow ball arm mechanism.....186
Diesel particulate filter (DPF).....156
Direction indicators.....71
Disabling the passenger
 airbag.....33
Disarming the alarm.....56
 Britain and Ireland only.....56
Disarming the engine
 immobiliser.....54
DPF
 See: Diesel particulate filter (DPF).....156
Driving hints.....196
- ## E
- Electric exterior mirrors.....89
 Electric folding mirrors.....89
 Mirror tilting positions.....89
Electric seats.....141
 2-way electric seat.....141
 6-way electric seat.....142
Electric sunroof.....135
 Opening and closing the sunroof.....135
 Opening and closing the sunroof automatically.....136
 Sunroof anti-trap protection.....136
 Sunroof relearning.....137
 Sunroof safety mode.....137
 Tilting the sunroof.....136
Electric windows.....86
 Isolating the rear window switches.....87
 Opening and closing a window automatically.....86
 Resetting the electric window memory.....88
 Window anti-trap protection.....87
Emergency equipment.....197
Engine compartment
 overview.....211
 1.4/1.6 l Duratec.....211
 1.6 l Duratec Ti-VCT.....212
 1.6 l Duratorq-TDCi.....215
 1.8/2.0 l Duratec-HE.....213
 1.8 l Duratorq-TDCi.....216
 2.0 l Duratorq-TDCi.....217
 2.5 l Duratec-ST.....214
Engine coolant check.....220

Index

- Engine immobiliser.....53
Principle of operation.....53
- Engine number.....245
1.4/1.6 I Duratec/Duratec Ti-VCT.....245
1.6/2.0 I Duratorq-TDCi Turbo diesel.....245
1.8/2.0 I Duratec-HE and 2.5 I Duratec-ST.....245
1.8 I Duratorq-TDCi Turbo diesel.....245
- Engine oil check.....218
Engine oil change.....220
Engine oil filler cap.....219
Engine oil top-up.....220
- Exterior mirrors.....88
Convex outside mirrors.....88
Folding outside mirrors.....89
- ## F
- Fastening the seat belts.....31
FocusST.....31
- First aid kit.....197
3-door and 5-door.....197
4-door.....197
Estate.....197
- Foot pedals
See: Adjusting the pedals.....59
- Front fog lamps.....66
- Fuel and refuelling.....157
Technical specifications.....159
- Fuel burning heater
See: Auxiliary heater.....199
- Fuel cut-off switch.....199
Vehicles with a Duratec engine.....199
- Fuel filler flap.....158
- Fuel quality.....157
Vehicles with a diesel engine.....158
Vehicles with a Flexfuel engine.....157
Vehicles with a petrol engine.....157
- Fuse box locations.....200
Auxiliary fuse box.....200
Central fuse box.....201
- Fuses.....200
- Fuse specification chart.....202
Engine junction box.....202
Passenger junction box.....204
- ## G
- Gauges.....95
Engine coolant temperature gauge.....96
Fuel gauge.....97
Information display.....97
Oil pressure gauge.....96
Oil temperature gauge.....96
Tachometer.....97
Turbocharger boost gauge.....96
- Gearbox
See: Transmission.....164
- General information on radio frequencies.....36
- Glasses holder.....150
- Global opening and closing.....51
Global closing.....52
Global opening.....51
- Glove box.....147
Cooled glove box.....147
- ## H
- Handbrake
See: Parking brake.....173
- Hazard warning flashers.....69
- Headlamp adjustment
See: Adjusting the headlamps.....67
- Headlamp levelling.....68
- Headlamp washers.....63
- Head restraints.....143
Adjusting the head restraint.....143
Removing the head restraint.....143
- Heated seats.....145

Index

Heated windows and mirrors.....	132
Heated exterior mirrors.....	133
Heated windows.....	132
Heating	
See: Climate control.....	125
Hints on driving with ABS.....	172
Horn.....	57

I

Ignition switch.....	151
Ignition switch positions.....	151
Immobiliser	
See: Engine immobiliser.....	53
Information displays.....	104
General information.....	104
Information messages.....	121
Inspecting safety system	
components.....	199
Seat belts.....	199
Instrument lighting dimmer.....	146
Instrument panel overview.....	
Instruments.....	91
Interior lamps.....	71
Centre console illumination.....	72
Reading lamps.....	72
Vanity mirror lamps.....	72
Interior mirror.....	90
Auto-dimming mirror.....	90
Introduction.....	5
ISOFIX anchor points.....	24
All except convertible.....	25

J

Jump starting	
See: Using booster cables.....	228

K

Keyless entry.....	45
Deactivating the key free	
function.....	51
General information.....	45
Locking the vehicle.....	50
Passive key.....	46
Unlocking the vehicle.....	48
Keys and remote controls.....	36

L

Lighting control.....	65
Autolamps.....	65
Headlamp flasher.....	66
Home safe feature.....	66
Main/dipped beam.....	65
Parking lamps.....	65
Lighting.....	65
Load carriers	
See: Roof racks and load carriers....	183
Load carrying.....	181
Locking and unlocking.....	41
Central and double locking.....	42
Doors.....	41
Tailgate.....	42
Locks.....	41
Luggage covers.....	181
3-door and 5-door.....	181
Estate.....	181

M

Maintenance.....	209
General information.....	209
Technical specifications.....	222

Index

- Manual climate control.....126
 Air conditioning.....127
 Air distribution control.....126
 Blower.....126
 Rapid heating of vehicle interior.....127
 Rapid windscreen
 defrosting/demisting.....127
 Recirculated air.....127
 Temperature control.....126
 Ventilation.....127
Manual seats.....138
 3-door.....140
 All vehicles.....138
 FocusST.....140
Manual transmission.....164
 Reverse gear – 5-speed
 transmission.....164
 Reverse gear – 6-speed
 transmission.....164
Message centre
 See: Information displays.....104
Mirrors
 See: Heated windows and mirrors..132
 See: Windows and mirrors.....86
- ## O
- Occupant protection.....27
 Principle of operation.....27
Oil check
 See: Engine oil check.....218
Opening and closing the
 bonnet.....210
Opening the convertible top.....190
 Luggage separator.....190
 Wind deflector.....191
- ## P
- Parking aid.....176
 Principle of operation.....176
Parking brake.....173
 All vehicles.....173
Parts and accessories.....6
Pedals.....59
Personalised settings.....108
 Advanced menu.....112
 Auxiliary heater programming.....116
 Chime deactivation.....120
 Clock setting.....114
 Deactivating the key free
 function.....115
 Language setting.....114
 Units of measure.....114
 Vehicle setup menu.....110
 Your settings – Exit.....120
 Your settings menu.....108
Power steering fluid check.....222
 Vehicles with a 1.4/1.6 l Duratec/1.6 l
 Duratec Ti-VCT engine.....222
 Vehicles with a 1.8/2.0 l Duratec-HE,
 2.5 l Duratec-ST and Turbo diesel
 engines.....222
Programming the remote
 control.....36
 Reprogramming the unlocking
 function.....37
- ## Q
- Quick start.....7
- ## R
- Rear fog lamps.....67
Rear seat armrest.....150
Rear seats.....144
 Folding the rear seatbacks
 forwards.....144
 Folding the seat cushions and
 seatback forwards.....144

Index

- Rear under floor storage.....181
3-door and 5-door with full-size spare wheel.....181
- Rear window wiper and washers.....62
Intermittent wipe.....62
Rear window washer.....63
Reverse gear wipe.....62
- Refuelling.....159
- Remote control battery
See: Changing the remote control battery.....37
- Removing a headlamp.....72
- Removing a rear lamp.....73
3-door and 5-door.....73
Convertible.....73
Estate.....73
- Repairing minor paint damage.....227
- Rollover bars.....32
- Roof racks and load carriers.....183
Estate.....183
- Running-in.....196
Brakes.....196
Engine.....196
Tyres.....196
- ## S
- Safety precautions.....157
- Seat belt height adjustment.....32
- Seats.....138
- Sitting in the correct position.....138
- Snow chains
See: Using snow chains.....241
- Speed control
See: Cruise control.....178
- Stability control.....174
Principle of operation.....174
- Starter switch
See: Ignition switch.....151
- Starting a diesel engine.....154
Cold/hot engine.....154
Vehicles with the key free system.....155
- Starting a petrol engine.....152
All vehicles.....152
Except vehicles with a Flexfuel engine.....152
Vehicles with a Flexfuel engine.....153
Vehicles with the key free system.....154
- Starting the engine.....151
General information.....151
- Status after a collision.....199
- Steering wheel.....57
- Storage compartments.....149
Front storage compartment.....149
- Sun blinds.....146
- Sunroof
See: Electric sunroof.....135
- Sun visors.....146
- Switching off the engine.....156
Vehicles with a diesel engine.....156
- Symbols glossary.....6
Symbols in this handbook.....6
Symbols on your vehicle.....6
- ## T
- Technical specifications.....246
Technical specifications.....246
- Toll reader.....150
- Towing a trailer.....186
Steep gradients.....186
- Towing points.....207
3-door, 4-door and 5-door.....207
All vehicles.....207
Estate.....207

Index

Towing the vehicle on four wheels.....	208
Towing vehicles with a key free system.....	208
Towing vehicles with automatic transmission.....	208
Towing.....	186
Transmission.....	164
Type approvals.....	262
Tyre care.....	235
Tyre pressure.....	235
Tyre repair kit.....	235
General information.....	235
Repairing a puncture.....	237
Using the ContiMobilityKit safely.....	236
Tyres	
See: Wheels and tyres.....	230

U

Using booster cables.....	228
To connect the booster cables.....	228
To start the engine.....	229
Using cruise control.....	178
Cancel and resume.....	179
Changing the stored vehicle speed.....	179
Storing the vehicle speed.....	178
Switching cruise control off.....	179
Switching cruise control on.....	178
Using seat belts during pregnancy.....	32
Using snow chains.....	241
Vehicles with stability control (ESP).....	241
Using stability control.....	175
Switching off ESP.....	175
Using the parking aid.....	176
Convertible only.....	177
Using winter tyres.....	241

V

Vehicle battery.....	228
Vehicle care.....	226
Vehicle identification number (VIN).....	245
Vehicle identification plate.....	245
Vehicle identification.....	245
Vehicle recovery.....	207
Ventilation	
See: Climate control.....	125
Vents	
See: Air vents.....	125
VIN	
See: Vehicle identification number (VIN).....	245
Voice control.....	58

Index

W

- Warning lamps and indicators.....98
 - ABS warning lamp.....98
 - Airbag warning lamp.....98
 - Brake system and ABS warning lamps.....99
 - Brake system warning lamp.....98
 - Cruise control indicator.....99
 - Direction indicator.....99
 - Doors open warning lamp.....99
 - Engine systems fault warning lamp.....99
 - Engine warning lamp.....99
 - Front fog lamp indicator.....99
 - Frost warning lamp.....100
 - Glow plug indicator.....100
 - Headlamp indicator.....100
 - Ignition warning lamp.....100
 - Low fuel level warning lamp.....100
 - Main beam indicator.....100
 - Maximum engine RPM warning lamp.....100
 - Oil pressure warning lamp.....100
 - Power steering warning lamp.....101
 - Rear fog lamp indicator.....101
 - Seat belt reminder.....101
 - Stability control (ESP) indicator.....101
- Warning triangle.....197
 - 3-door and 5-door.....197
 - 4-door.....198
 - Estate.....198
- Washer fluid check.....222
- Washers
 - See: Wipers and washers.....60
- Washing
 - See: Cleaning the exterior.....226
- Wheels and tyres.....230
 - Technical specifications.....241
- Windows and mirrors.....86
- Windscreen washers.....62
- Windscreen wipers.....60
 - Automatic wiper system.....61
 - Autowipers.....60
 - Intermittent wipe.....60
- Winter tyres
 - See: Using winter tyres.....241
- Wipers and washers.....60



